



www.fleet.vdo.com

Digital tachograph – DTCO[®] 4.1 ... 4.1a

Instruction manual for contractors and drivers

EN

VDO
Smart on the Road

Legal notice

Described product

- Digital tachograph DTCO 1381
Release DTCO 4.1 and DTCO 4.1a

Scope of validity

This document applies to all DTCO versions 4.1 and 4.1a, referred to as 4.1x below.

Content which only applies to a particular version is referred to using the respective individual version name.

Manufacturer

Continental Automotive Technologies
GmbH
P.O. Box 1640
78006 Villingen-Schwenningen
Germany
www.fleet.vdo.com

Original operating instructions

© 2024
Continental Automotive Technologies
GmbH

This work is protected by copyright. The rights arising from this copyright remain with Continental Automotive Technologies GmbH.

Reprinting, translations and reproductions are not permitted unless authorised in writing by the manufacturer.

This is an original document of
Continental Automotive Technologies
GmbH.

Brands and trademarks:

- VDO® is a brand of Continental Automotive Technologies GmbH
- DTCO® and KITAS® are registered trademarks of Continental Automotive Technologies GmbH
- Bluetooth® is a registered trademark of Bluetooth SIG, Inc.

Any other registered brands and trademarks are used without separate reference to the owner.

Contents

Legal notice	2	2.3 Intended use.....	18
1 About this document	9	3 Device description	20
1.1 Data protection	9	3.1 Display and operational elements	20
1.1.1 Personal ITS data	10	3.2 Features	20
1.1.2 Personal VDO data	10	3.2.1 Transitional tachograph.....	21
1.2 Designations	10	3.3 Details to the display and operating elements	23
1.3 Function of this document.....	11	3.3.1 Display (1).....	23
1.4 Target group	11	3.3.2 Menu buttons (2).....	23
1.4.1 Storage.....	11	3.3.3 Card drawer 1 (3).....	23
1.4.2 Contact person.....	11	3.3.4 Driver 1 combination button (4).....	23
1.5 Symbols and signal words.....	12	3.3.5 Driver 2 combination button (5).....	23
1.6 Additional information	12	3.3.6 Card drawer 2 (6).....	23
1.6.1 Quick guide	12	3.3.7 Tear-off edge (7)	23
1.6.2 Information via the internet.....	12	3.3.8 Printer drawer (8)	23
2 For your safety	14	3.3.9 Front interface (9).....	24
2.1 Basic safety information.....	14	3.4 Key settings (overview)	24
2.1.1 DTCO 4.1x ADR (ex variant).....	15	3.5 Bluetooth	24
2.2 Legal requirements	16	3.6 Stand-by mode (display).....	25
2.2.1 Driver card: Obligations of the driver	16	3.6.1 Exiting stand-by mode.....	25
2.2.2 Departure from legal requirements	17	3.7 ADR version (Ex version)	25
2.2.3 Obligations of the contractor	17	3.7.1 Special safety instructions.....	26
		3.7.2 Particularities in relation to the operation ...	26
		3.8 Operating modes (overview)	27
		3.9 Tachograph card (overview).....	29

3.9.1	Driver card.....	29
3.9.2	Company card.....	29
3.9.3	Control card.....	30
3.9.4	Workshop card.....	30
3.9.5	Access rights of the tachograph cards	30
3.10	Saved data.....	32
3.10.1	Driver card.....	32
3.10.2	Company card.....	32
3.10.3	Mass memory (in the device)	32
3.11	Border crossing.....	33
3.12	Time zones	33
3.13	Pictograms (overview).....	35
3.14	Country symbols	39
3.14.1	Spanish regions	41
3.15	Automatic activities after ignition on/off (default)	41
4	Operation (general).....	44
4.1	Displays	44
4.1.1	Display after ignition on.....	44
4.1.2	Displays during journey.....	44
4.1.3	Messages.....	46
4.1.4	Display after ignition off.....	46
4.2	Navigating within menus.....	46
4.2.1	Menus while vehicle is stationary	46
4.3	Inserting card.....	47

4.3.1	Language	48
4.4	Removing the card	49
4.5	Handling of the cards.....	50
4.6	Downloading data.....	50
4.6.1	From driver or company card	50
4.6.2	Data identification.....	51
4.6.3	Downloading from the mass memory.....	51
4.6.4	Remote-controlled download (option)	51

5 Operation by the driver **53**

5.1	Driver card functions.....	53
5.2	Shift start – Inserting driver card	53
5.2.1	1. Inserting card	53
5.2.2	2. Setting activity	57
5.2.3	Country entry – manual.....	57
5.2.4	Aborting the entry procedure.....	58
5.3	Setting activities.....	59
5.3.1	Possible activities.....	59
5.3.2	Changing activities.....	59
5.3.3	Automatic setting.....	59
5.3.4	Recording activities manually.....	60
5.4	Load/unload (cabotage).....	61
5.5	Shift end – removing driver card.....	61
5.6	Manual entries (entry/addition).....	63
5.6.1	Card requests during the manual entry	63

5.6.2	Adding activity rest time	64	7.1.4	VDO Counter (option)	81
5.6.3	Continuing activities	65	7.2	Second menu level – menu functions.....	87
5.6.4	Continuing activities and preceding others with activities	66	7.2.1	Menu structure (overview).....	87
5.7	Driver / vehicle change	67	7.2.2	Navigating within menu functions.....	89
5.7.1	Case 1 – Crew operation	67	7.2.3	Menu access lock.....	90
5.7.2	Case 2 – Shift end.....	67	7.2.4	Leaving menu functions	90
5.7.3	Case 3 – Mixed operation	67	7.2.5	Menu point printout driver 1/ driver 2	91
5.8	Inserting driver card for the first time	68	7.2.6	Menu point printout vehicle	92
5.8.1	Data usage	68	7.2.7	Menu point Entry driver 1/driver 2	95
5.8.2	Registration process	68	7.2.8	Menu point entry vehicle	99
6	Operation by the contractor	71	7.2.9	Menu point display driver 1/ driver 2	104
6.1	Functions of the company card.....	71	7.2.10	Menu point display vehicle	105
6.2	Menu functions in the company mode	72	7.2.11	Centralised language (option).....	106
6.3	Registration – inserting company card	72	7.2.12	Menu point Toll (option)	107
6.4	Inserting member state and vehicle registration number	74	8	Messages	109
6.5	Removing company card	76	8.1	Meaning of messages	109
7	Menus	79	8.1.1	Characteristics of the messages	109
7.1	First menu level – Standard values	79	8.1.2	Acknowledgement of messages	110
7.1.1	Display in stationary vehicle	79	8.2	Special messages	110
7.1.2	Display the times of the driver card	80	8.2.1	Production status	110
7.1.3	Setting the language	81	8.2.2	OUT (out of scope of regulation).....	111
			8.2.3	Ferry/ train.....	111
			8.3	Overview of possible events	112
			8.4	Overview of possible malfunctions	115
			8.5	Driving time warnings	118

8.5.1	VDO Counter display (option)	119	10.2.10	Speed profiles (option)	137
8.6	Overview of possible operational notes	120	10.2.11	Rotation frequency profiles (option)	137
8.6.1	Operational notes as information	123	10.2.12	Inserted tachograph cards	137
9	Print	126	10.2.13	Printout in local time	138
9.1	Notes for printing	126	10.3	Explanation to the printouts	138
9.2	Starting print	126	10.3.1	Key to the data blocks.....	139
9.3	Cancel print.....	127	10.4	Data set for events or faults.....	148
9.4	Replacing the printer paper	127	10.4.1	Coding of data set purpose.....	148
9.4.1	End of paper.....	127	10.4.2	Coding for more detailed description	150
9.4.2	Replacing the paper roll	127	11	Maintenance and inspection obligation	152
9.5	Clear paper jam	128	11.1	Cleaning	152
10	Printouts	130	11.1.1	Cleaning the DTCO 4.1x.....	152
10.1	Retaining printouts	130	11.1.2	Cleaning tachograph card	152
10.2	Printouts (examples).....	130	11.2	Compulsory inspection	152
10.2.1	Daily printout of the driver card	130	12	Troubleshooting	155
10.2.2	Events / faults from the driver card	132	12.1	Data backup by the workshop	155
10.2.3	Daily printout of the vehicle	132	12.2	Overvoltage/undervoltage	155
10.2.4	Events / faults from the vehicle	134	12.2.1	Power interruption	156
10.2.5	Speeding events	135	12.3	Error card communication	156
10.2.6	Technical data	135	12.4	Printer drawer defect	157
10.2.7	Driver activities.....	136	12.5	Automatic ejection of tachograph card	157
10.2.8	v-diagram	136	13	Technical data.....	159
10.2.9	Status D1/D2 diagram (option).....	136			

13.1 DTCO 4.1x..... 159

13.2 Paper roll 160

14 Appendix 163

14.1 Declaration of conformity/Authorisations 163

14.2 Optional accessories 173

 14.2.1 DLK Smart Download Key 173

 14.2.2 DLKPro Download Key S 173

 14.2.3 DLKPro Compact S 173

 14.2.4 Remote DL 4G 174

 14.2.5 VDO Link..... 174

 14.2.6 Cleaning cards and cleaning wipes..... 175

14.3 VDO online shop..... 175

15 Change overview 177

15.1 Release overview 177

Index 180

About this document

Data protection

Designations

Function of this document

Target group

Symbols and signal words

Additional information

About this document

■ Data protection

Regulation (EU) 165/2014 and Implementation Regulation (EU) 2016/799 as amended place several requirements on the DTCO 4.1x in terms of data protection. In addition, the DTCO 4.1x fulfils the requirements of the General Data Protection Regulation (EU) 2016/679, as amended.

This particularly affects:

The first time the driver card is inserted into the DTCO 4.1x, the equipment will prompt whether the driver consents to the processing of his personal data.

IMPORTANT

The DTCO 4.1x can be parameterised in such a way that it processes data even without the driver's consent. However, this setting is only permitted if a

data protection agreement between the drivers and the employee / client was signed instead.

IMPORTANT

Further information relating to data protection, particularly with respect to data collection and data usage, are available from your employer and/or client. Please note that Continental Automotive Technologies GmbH acts solely as a processor in accordance with your employer/client.

IMPORTANT

Please note that any given consent can be revoked at any time. Any data processing based on your consent carried out up to the revocation is not affected by this.

→ *Changing settings to personal ITS data* [▶ 97]

→ *Changing settings to personal VDO data* [▶ 97]

IMPORTANT

The data is saved in the tachograph and, after reaching the maximum data volume, systematically overwritten one by one, starting with the oldest entries – after one year at the earliest.

External devices communicating with the tachograph can access the data described below, provided the driver has consented to the recording.

IMPORTANT

Further data protection information regarding personal data can be found under <https://www.fleet.vdo.com/support/faq/>.

► Personal ITS data

Personal ITS data (ITS: Intelligent Transport System) include, for example:

- Driver's first and last name
- Driver card number
- Date of birth

Consent on first insertion of the driver card → *Registration process* [▶ 68]

► Personal VDO data

The following personal additional data is recorded:

- D1/ D2-Status inputs
- Engine speed profiles
- Speed profiles
- the 4 Hz speed signal

Consent on first insertion of the driver card → *Registration process* [▶ 68]

IMPORTANT

For further information about data collection, please contact your employer.

■ Designations

The following designations apply in these operating instructions:

- The DTCO 1381 Release 4.1a is referred to below as DTCO 4.1x.
- The **front interface** → *Display and operational elements* [▶ 20] of the DTCO 4.1x is used for downloading data and parameterising the DTCO 4.1x.
- The **AETR Agreement** (**A**ccord **E**uropéen sur les **T**ransports **R**outiers) specifies provisions for the driving and rest times for cross-border transport. It therefore also forms part of these instructions.
- **Mixed operation** Mixed operation Means the mixed use of vehicles with analogue and digital tachographs.
- **Crew operation** Means a journey with 2 drivers.
 - Driver 1 = the person driving the vehicle.
 - Driver 2 = the person not driving the vehicle.

- **Mass memory** is the data memory in the device.
- **Out** (Out of Scope) throughout these instructions means leaving the scope of a regulation.

■ Function of this document

These are the operating instructions outlining the correct use in compliance with the operation specified in Regulation (EU) 165/2014 of the digital tachograph DTCO 4.1x.

The operating instructions are to assist you in complying with the legal regulations in connection with the DTCO 4.1x.

This document is not valid for older device generations.

■ Target group

This instruction manual is aimed at drivers and contractors.

Please read the manual carefully and familiarise yourself with the device.

► Storage

Please always have this manual at hand in your vehicle.

► Contact person

If you have any questions or requests, please contact your authorised specialist workshop or service partner.

■ Symbols and signal words

RISK OF EXPLOSION!

The note EXPLOSION RISK refers to an **imminent** danger of explosion.

Non-compliance may result in severe injury or death.

WARNING

The note WARNING refers to **possible** danger.

Non-compliance may result in serious injuries or death.

CAUTION

The note CAUTION refers to the risk of minor injuries.

Non-compliance may result in minor injuries.

ATTENTION

The note ATTENTION contains important information to avoid data loss, prevent damage to the device and comply with legal requirements.

IMPORTANT

A NOTE provides you with advice or information which, if not adhered to, could result in malfunctions.

■ Additional information

▶ Quick guide

- The purpose of the “driver quick guide” is to provide a quick overview of the essential operating steps.

▶ Information via the internet

The following is available in the internet under www.fleet.vdo.com:

- Further information on the DTCO 4.1x
- An app to operate the DTCO 4.1x via Bluetooth
- Information on the third party licence
- These operating instructions in pdf format
- Contact addresses
- Requirements for external GNSS antennas run with the DTCO 4.1x

For your safety

Basic safety information

Legal requirements

Intended use

For your safety

■ Basic safety information

WARNING

Distraction due to device messages

There is a risk of distraction if messages are displayed on the device while driving or if the card is automatically ejected.

- Do not let yourself get distracted by this, but focus all of your attention on the traffic.

CAUTION

Risk of injury at the card drawer

You and others may sustain an injury on an open card drawer.

- Only open the card drawer to insert or remove a tachograph card.

ATTENTION

Carry out training on the DTCO 4.1x

Pursuant to Regulation (EU) 165/2014, road transport operators are obliged to train their drivers in the use of digital tachographs and to provide proof of such training.

Failure to comply can result in a fine and extended liability in the event of damage.

- Have your drivers attend regular training.

ATTENTION

Avoid damage to the DTCO 4.1x

In order to prevent the DTCO 4.1x from getting damaged, please note the following points:

- Authorised persons installed and sealed the DTCO 4.1x. Do not carry out any repairs at the DTCO 4.1x and the supply lines.
- Insert only the corresponding tachograph cards into the card drawer.
- Use only paper rolls with approval mark which have been approved and recommended by the manufacturer (original VDO printer paper).
→ *Replacing the printer paper* [[127](#)]
- Do not use sharp or pointed objects to operate the keys.

⚠ ATTENTION**Do not damage sealings and seals**

Otherwise, the DTCO 4.1x is in non-compliant condition and the data is no longer reliable.

⚠ ATTENTION**Do not manipulate data**

It is forbidden to falsify, suppress or destroy tachograph recordings, the tachograph cards and the printed documents.

⚠ ATTENTION**Do not change the DTCO 4.1x and surroundings**

- Any person making changes to the tachograph or the signal feed in a way that influences the recording

and memory of the tachographs, especially if done with fraudulent intentions, violates legal regulations.

- It is not permitted to carry out any changes within 80 mm, especially through devices with magnetic radiation (e.g. DVD players). It is not permitted to attach any metallic or electric parts.
- When operating devices which are not part of the vehicle's standard equipment, it must be ensured that they do not interfere with the function (especially the GNSS reception) of the tachograph. This may result in corresponding entries in the error memory (tachograph, driver card).

▶ DTCO 4.1x ADR (ex variant)

For better clarity, all details (particularities in relation to the operation and relevant safety information) regarding the ex version ADR have been summarised in one single chapter.

⚠ RISK OF EXPLOSION!**Risk of explosion due to residual voltages and open interfaces**

In explosive areas, operating the buttons of the DTCO 4.1x, inserting cards, opening the printer drawer or opening the front interface, posts an explosion risk.

- Please observe the instructions for the transport and handling of hazardous goods in explosive environments.

→ *ADR version (Ex version)* [▶ 25]

■ Legal requirements

⚠ ATTENTION

Legal requirements of other countries

This instruction manual does not list the legal requirements of individual countries, and these must also be observed.

The use of tachographs is regulated by the following regulations and directives:

- Regulation (EU) 165/2014
- Regulation (EC) 561/2006
- Directive 2006/22/EC

The most recent versions apply.

By means of these Regulations, the European Parliament assigns a number of duties and responsibilities to the driver of the vehicle as well as to its owner (contractor).

In addition, the respective national laws must also be observed.

Without any claim to completeness or validity, the following key points can be highlighted:

► Driver card: Obligations of the driver

- The driver must ensure that the driver card and the tachograph will be used properly.
- Behaviour in the event of malfunctions of the tachograph:
 - Continuing the journey is possible in exceptional cases.
The driver must write down on a separate sheet or on the back of the printout any details about the activities which are no longer properly recorded or printed by the tachograph.
→ *Recording activities manually* [▶ 60]
 - If a return to the contractor's site cannot occur within a week, the tachograph must be repaired during the journey by an authorised specialist workshop.

- Documents to be carried during mixed operation (use of vehicles with record sheet and digital tachograph):
 - Driver card
 - Daily printouts
 - Tachograph charts
 - Hand-written records
→ *Driver / vehicle change* [▶ 67]

IMPORTANT

A printable version of the form is available in the Internet.

- In case of loss, theft, damage or malfunction of the driver card:
The driver must create a daily printout at the start and at the end of the journey and include personal details. If necessary, the availability and other working times must be amended by handwritten entries.
→ *Recording activities manually* [▶ 60]

- If the driver card is stolen, this must also be reported to the police. Only then can a new card be requested at the local authority upon presentation of the police notification.
 - In case of loss of the driver card, a declaration on oath must be made to be able to receive a new card. If the old card is found again, it must be handed in.
 - In case of damage or malfunction of the driver card:
Hand the card over to the relevant authority.
The replacement card must be requested within 7 calendar days.
 - A journey may be continued without driver card for a period of 15 calendar days or longer if necessary for the return of the vehicle to the company location.
 - If the authority of a foreign member state replaces the driver card: Immediately notify your relevant authority of the reason.
 - The driver card is valid for 5 years. Upon expiry of the validity of the driver card, the driver must carry the card in the vehicle for at least another 56 calendar days.
 - The card will only be withdrawn if it turns out that it was forged or another driver uses or has used the card. Or if the driver card was requested under false pretences and/or using forged documents. This means that even in case of a driving licence withdrawal or a driving ban, the card may remain with the driver.
- **Departure from legal requirements**
- In order to ensure the safety of persons, the vehicle or the transported goods, deviations from the applicable legal provisions may be necessary.
- In such cases, the driver must indicate the type and reason of the deviation with handwritten entries at the latest on arrival at a suitable stopping place. For example:

- On the tachograph chart
- On a printout from the DTCO 4.1x
- In the work schedule

► **Obligations of the contractor**

The calibration and repair of the DTCO 4.1x may only be carried out by an authorised specialist workshop.

➔ *Compulsory inspection* [► 152]

- After a vehicle delivery and if not already happened:
Have an authorised specialist workshop enter the following data of the calibration into the DTCO 4.1x:
 - Member state
 - Vehicle registration number
- Log in/out the company at the start/end of the vehicle use in the DTCO 4.1x.
 - ➔ *Registration – inserting company card* [► 72]
- Make sure that enough authorised rolls of paper for the printer are available in the vehicle.

- Monitor the proper functioning of the tachograph, e.g. by inserting the company card.
- Observe the statutory intervals provided for checking the tachograph: Test at least every two years.
- Download the data from the data memory of the DTCO 4.1x and from the driver cards at regular intervals and store the data according to the legal stipulations.
- Supervise the proper use of the tachograph by the drivers. Check driving times and rest periods periodically and compare these with the legal requirements.

■ Intended use

The digital tachograph DTCO 4.1x is a recording device for monitoring and registering speed, kilometres travelled and driving/rest periods.

This document describes the operation of the digital tachograph DTCO 4.1x.

The data processed by this tachograph supports you in your daily tasks:

- For example, they help you, the driver, to observe the social legislation relating to road transport.
- They help you, the contractor, to keep an eye on the driver and vehicle use (by means of appropriate evaluation programs).

It is stipulated for the ADR variant of the DTCO 4.1x that it can only be operated according to the specifications of ATEX Directive 2014/34/EU.

IMPORTANT

The certificate of the DTCO 4.1x expires after 15 years. After this period, the DTCO 4.1x can no longer be used.

- By default, a notification is generated 92 days before expiry
- Date of first use → *Technical data* [▶ 135]

Device description

Display and operational elements

Features

Details to the display and operating elements

Key settings (overview)

Bluetooth

Stand-by mode (display)

ADR version (Ex version)

Operating modes (overview)

Tachograph card (overview)

Saved data

Border crossing

Time zones

Pictograms (overview)

Country symbols

Automatic activities after ignition on/off (default)

Device description

■ Display and operational elements

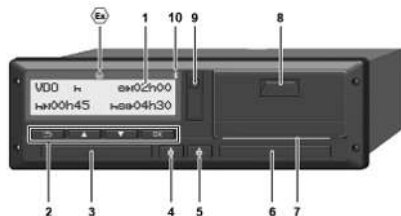

Fig. 1: Frontal view DTCO 4.1x

- (1) Display
- (2) Menu buttons
- (3) Card drawer 1 with cover
- (4) Combination key driver 1
- (5) Combination key driver 2
- (6) Card drawer 2 with cover
- (7) Cutting edge printer
- (8) Printer drawer
- (9) Front interface
- (10) Bluetooth symbol

The DTCO 4.1x can be remotely controlled with optional accessories.

For this you will need:

- An external device with Bluetooth interface, e.g. smartphone or test device.
- Suitable application software (app) on the external device. See www.fleet.vdo.com



Symbol for ADR variant (Ex variant – option)

IMPORTANT

The card shaft covers may not be removed to prevent the penetration of dust and dirt or splash water!

- Always keep the card drawers closed.

■ Features

The digital tachograph DTCO 4.1x and its system components is the vehicle unit of a tachograph or recording equipment of the second generation (smart tachograph V2) according to the requirements of Regulation (EU) No. 165/2014 as well as currently applicable Implementing Regulation (EU) 2016/799 Annex I C.

The DTCO 4.1x continuously registers driver and vehicle data.

Errors in a component, in the device, or in the operating procedure will be displayed and stored immediately after occurrence:

For the ADR variant, the DTCO 4.1x complies with ATEX Regulation 2014/34/EU and the ADR Agreement, part 9.

► Transitional tachograph

Transitional tachograph

Transitional tachographs cannot authenticate the navigation messages available according to the declaration of the OS-NMA services.

In the case of a transitional tachograph, every position is therefore displayed as an authenticated position.

Intelligent tachograph version 2 with full OS-NMA functionality

Intelligent tachographs version 2 with full OS-NMA functionality can authenticate the navigation messages available according to the declaration of the OS-NMA services.

EU Declaration of services

If the EU publishes a declaration of services that the functions OS-NMA can be authenticated:

- After this publication, transitional tachographs may only be installed in newly registered vehicles for a period of 5 months.
- In the case of vehicles registered before the end of this period, transitional tachographs or intelligent tachographs version 2 with full OS-NMA functionality may be installed even after this period.

After this period, only intelligent tachographs version 2 with full OS-NMA functionality may be installed in newly registered vehicles.

Configuration of the DTCO 4.1a

According to Implementing Regulation 2023/980/EU, the DTCO 4.1a is approved both as a transitional tachograph and an intelligent tachograph version 2 with full OS-NMA functionality.

The DTCO 4.1a can be configured as a transitional tachograph in compliance with Implementing Regulation 2023/980/EU.

Configuration before activating the DTCO 4.1a

A switch between transitional tachograph and intelligent tachograph version 2 with full OS-NMA functionality is possible for an unlimited period via software setting before activating the DTCO 4.1a.

Configuration after activating the DTCO 4.1a

After activating the DTCO 4.1a, only one single irreversible switch from a transitional tachograph to an intelligent tachograph version 2 with full OS-NMA functionality will be possible.

Configuration of the DTCO 4.1

The DTCO 4.1 is a transitional tachograph according to Regulation 2023/980/EU.

Therefore, it may only be installed in newly registered vehicles up to the end of the period of 5 months after the above-mentioned publication.

3

IMPORTANT

A DTCO 4.1 can be upgraded to a DTCO 4.1a via a software update.

Detecting the set configuration**IMPORTANT**

The "SW Version" view which is available via the service menu or a restart does **not** include the information whether the DTCO 4.1a was configured as a transitional tachograph.

The set configuration is visible:

- in the display of the "DTCO Version" view
- in the calibration information

Display in the display:

Menu: `Display > vehicle > DTCO version.`

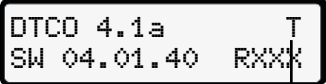
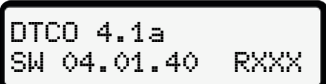
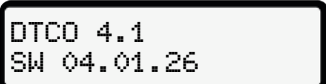
 <p style="text-align: center;">"T"</p>	<p>DTCO 4.1a:</p> <p>The "T" (Transitional) indicates that the DTCO 4.1a is configured as a transitional tachograph.</p>
	<p>DTCO 4.1a:</p> <p>If no "T" is displayed, the DTCO 4.1a is configured as an intelligent tachograph.</p>
	<p>DTCO 4.1:</p> <p>The DTCO 4.1 is always a transitional tachograph. Therefore, no "T" is displayed.</p>

■ Details to the display and operating elements

▶ Display (1)

IMPORTANT

Except for the standby mode, the display cannot be completely switched off. It is only dimmed to a minimum value.



Contrast and brightness of the displays cannot be changed.

Dimming (after ignition off) can be modified in the workshop.

Depending on the vehicle's operational condition, different displays will appear or data can be displayed.

▶ Menu buttons (2)

Please use the following buttons to enter, display or print data:

  **Press the button of the desired direction several times:** Scroll through the menu level to the desired function.

Keep the button pressed: Scroll automatically.

 **Press the button briefly:** Confirm the function/selection.

 **Press the button briefly:** Return to the previous entry field, abort the country entry or exit the menu levels step by step

▶ Card drawer 1 (3)

Driver 1 who will drive the vehicle inserts his driver card into drawer 1.

→ *Shift start – Inserting driver card* [[▶ 53](#)]

▶ Driver 1 combination button (4)

 **Press the key for a short time:** Change activity.
→ *Setting activities* [[▶ 59](#)]
Keep the key pressed (at least 2 seconds): Open the card drawer.

▶ Driver 2 combination button (5)

 **Press the key for a short time:** Change activity.
→ *Setting activities* [[▶ 59](#)]
Keep the key pressed (at least 2 seconds): Open the card drawer.

▶ Card drawer 2 (6)

Driver 2, who is not driving the vehicle at this moment in time, inserts his driver card into drawer 2 (crew operation).

→ *Shift start – Inserting driver card* [[▶ 53](#)]

▶ Tear-off edge (7)

You can tear off the paper printout of the printer at the tear-off edge.

▶ Printer drawer (8)

Printer drawer for insertion of the paper roll.

→ *Replacing the printer paper* [[▶ 127](#)]

► Front interface (9)

Data download and parameterisation are carried out via the front interface (workshop).

The front interface is located under a cover.

The access rights in relation to the functions of this interface depend on the tachograph card inserted.

➔ *Access rights of the tachograph cards* [▶ 30]

■ Key settings (overview)

Important settings on the DTCO 4.1x include:

- Entering the vehicle registration number and the country of registration (if not already carried out by the workshop)
➔ *Inserting member state and vehicle registration number* [▶ 74]
- Activity changes when the ignition is off
➔ *Automatic activities after ignition on/off (default)* [▶ 41]
- Recording of speed and revolutions/min. profiles
➔ *Printing speed profiles (option)* [▶ 95]
- D1/D2 status detection
➔ *Shift start – Inserting driver card* [▶ 53]
- VDO Counter display (option)
➔ *VDO Counter (option)* [▶ 81]

■ Bluetooth

The DTCO 4.1x can be remotely controlled or read via Bluetooth.

For this you need:

- An external device with Bluetooth interface, e.g. a smartphone or a test device.
- Suitable application software (app) on the external device:
www.fleet.vdo.com.

Bluetooth activation:

- ➔ *Registration process* [▶ 68]
- or
- ➔ *Bluetooth pairing* [▶ 97]

If an external device is paired via Bluetooth and an active connection to this device exists, a "*" will appear in the upper row of the standard display: ➔ *Displays* [▶ 44].

Entry of the registration number

Entry of the registration number and the authorising member state can also be carried out via an app: www.fleet.vdo.com.

■ Stand-by mode (display)

In the operating mode *“operational”*, recognisable in the display by the pictogram , the DTCO 4.1x switches to Stand-by mode in the following circumstances:

- Vehicle's ignition is off.
- No message is pending.

If *“Ignition off”*, the display is dimmed.

After approx. 1 minute (customer-specific value), the display goes out completely – the DTCO 4.1x is in stand-by-mode.

A further dimming value can optionally be set (workshop).

► Exiting stand-by mode

By pressing any button, ignition on or the end of interruption the stand-by mode is exited.

The display lights up again; no further action occurs.

■ ADR version (Ex version)

The ADR variant of the DTCO 4.1x is marked with an ex symbol on the front plate.

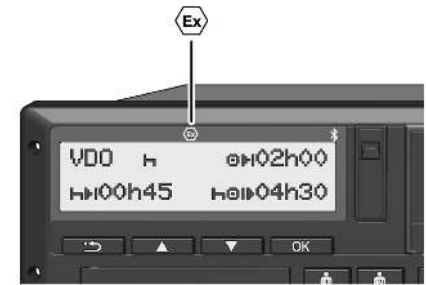

Fig. 2: Ex symbol on the front side

The ADR variant of the DTCO 4.1x is approved for use in explosive environments.

- Ex zone: Zone 2
- Ambient temperature: -20 °C to +65 °C

For ADR variants for which the operating mode *“Loading or unloading hazardous materials”* is only recognised through *“Ig-*

3

nition off", the DTCO 4.1x asks the driver if it is the ADR mode. If this is the case, all measures stated in the following must be observed. The driver's selection is saved in the vehicle unit.

► Special safety instructions

The following additional safety information must be observed for the ADR variant of the DTCO 4.1x:

RISK OF EXPLOSION!

Observe instructions

- Please observe the instructions for the transport and handling of hazardous goods in explosive environments.

RISK OF EXPLOSION!

Observe when loading and unloading hazardous materials:

- Both card drawers must be closed.
- The printer drawer must be closed.
- The cover of the front interface must be closed.
- Do not press any buttons on the tachograph.
- No workshop, control or company card must be inserted.
- No add-on devices (e.g. VDO Link) may be inserted.

► Particularities in relation to the operation

To protect from explosion, the ADR variant of the DTCO 4.1x is reduced to internal functions while the ignition is turned off in certain hazard areas (in contrast to the standard variant).

You can use all functions of the DTCO 4.1x outside of the hazard area while the ignition is switched on.

■ Operating modes (overview)

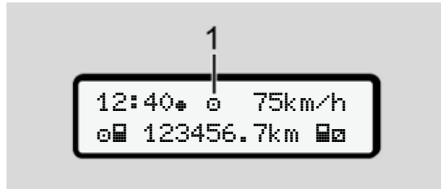





Fig. 3: Display relating to operating mode

(1) Display of the operating mode

The DTCO 4.1x has 4 operating modes which each depend on the tachograph card inserted:

- Operation  (journey/driver)
Standard display with or without driver card inserted
→ *Shift start – Inserting driver card*
[▶ 53]
- Company  (contractor)
Display after inserting the company card
→ *Registration – inserting company card* [▶ 72]
- Control 
(Not part in this manual)

- Calibration 
(Not part of this manual)

Depending if and which tachograph cards are inserted, the DTCO 4.1x automatically switches to one of the following operating modes:

3

Overview of operating modes of inserted tachograph cards

Operating modes		Card drawer 1				
		No card	Driver card	Company card	Control card	Workshop card
Card drawer 2	No card	Operation	Operation	Company	Control	Calibration
	Driver card	Operation	Operation	Company	Control	Calibration
	Company card	Company	Company	Company (*)	Operation	Operation
	Control card	Control	Control	Operation	Control (*)	Operation
	Workshop card	Calibration	Calibration	Operation	Operation	Calibration (*)

(*) In these states, the 4.1x only uses the tachograph card inserted in the card drawer 1.

■ Tachograph card (overview)

You will obtain the legally required tachograph cards by requesting them from the authorities of the respective EU member state.

➔ *Access rights of the tachograph cards*
[▶ 30]

IMPORTANT

You can use tachograph cards of the first generation according to (EU)3821/85, Annex I B and the second generation according to Implementation Regulation(EU) 2016/799, Annex I C, as amended.

However, only second generation workshop cards may be used.

The DTCO 4.1x has an optional function to permanently prevent the use of first generation tachograph cards. This function can be activated by workshops following the instruction of the EU.

Possession of a tachograph card authorises the holder to use the DTCO 4.1x. Areas of activity and access rights are prescribed by law.

➔ *Access rights of the tachograph cards*
[▶ 30]

IMPORTANT

In order to prevent data loss, please handle your tachograph carefully and also observe the instructions of the authorities issuing the tachograph cards.

▶ Driver card

You use your driver card to log yourself into the digital tachograph as a driver.

The DTCO 4.1x starts displaying and storing all activities of this driver.

You can print or download (with a driver card inserted) the data.

Thus, the driver card is used for normal driving operation (as single driver or in crew operation).

▶ Company card

You use the company card to log yourself into the DTCO 4.1x as the vehicle holder or owner. This enables you to access company data.

The company card is used to display, print and download the data saved in the data memory as well as the data of a driver card - which is inserted into the other card drawer.

IMPORTANT

In addition, the company card entitles you – for the first time and if not yet carried out by a workshop – to enter the authorised member state and the vehicle registration number. If in doubt, please contact an authorised specialist workshop.

Equipped with a corresponding fleet management system, the company card also authorises you to remotely download the user data.

IMPORTANT

The company card is designed for keepers and owners of vehicles with integrated digital tachograph and must not be transferred to other persons. The company card is not designed for driving.

► Control card

(Not part of this manual)

The control card of the officer of a supervisory body (e.g. police) allows access to the mass memory.

All saved data and the data of an inserted driver card are accessible. They can be displayed, printed out or downloaded via the front interface.

► Workshop card

(Not part of this manual)

Persons of an authorised specialist workshop who are approved to programme, calibrate, activate, test, etc. will receive the workshop card.

► Access rights of the tachograph cards

The rights to access data saved in the data memory of the DTCO 4.1x are regulated by law and will be released with the corresponding tachograph card only.

		Without card	Driver card	Company card	Control card	Workshop card
Print	Driver data	X	V	V	V	V
	Vehicle data	T1	T2	T3	V	V
	Parameter	X	V	V	V	V
Display	Driver data	T1	T2	T3	V	V
	Vehicle data	V	V	V	V	V
	Parameter	X	T2	V	V	V
Read out	Driver data	X	X	T3	V	V
	Vehicle data	X	X	V	V	V
	Parameter	X	V	V	V	V

Meanings:

Driver data	Data on the driver card
Vehicle data	Data in the data memory
Parameter data	Data for the device adjustment/calibration
V	Unlimited access rights
T1	Driver activities of the last eight days without driver identification data
T2	Driver identification only for the inserted card
T3	The associated company's driver activities
X	not possible

■ Saved data

► Driver card

The driver card generally contains:

- Data for identifying the driver.
→ *Personal ITS data* [10]

The following data is stored on the driver card chip after each vehicle use:

- Insertion and removal of the card
- Used vehicles
- Date and odometer reading
- Activities of the driver, during normal driving operation at least 56 days
- Kilometres travelled
- Country entries
- Status information (single or crew operation)
- Appearing events / faults
- Information concerning control activities
- Specific conditions:
 - Journeys with ferry/train status

- Journeys with OUT status (out of scope)
- Time and location of loading/unloading (cabotage)
- Time and location of the border crossing (Posted Workers Directive)

When the internal memory is full, the DTCO 4.1x overwrites the older data.

→ *Driver card: Obligations of the driver* [16]

► Company card

The company card generally contains:

- Data for identifying the company and authorising access to stored data.

After each use, the following data is stored on the company card:

- Type of activity
 - Log in/log out
 - Downloading the data from the data memory

- Downloading the data from the driver card
- Time period (from / to) from which the data was downloaded
- Vehicle ID
- Identity of the driver card from which the data was downloaded

When the chip memory is full, the DTCO 4.1x overwrites the older data.

→ *Obligations of the contractor* [17]

► Mass memory (in the device)

- Over a period of at least 365 calendar days, the mass memory collects and stores the data according to Implementation Regulation (EU) 2016/799 Annex I C, as amended.
- The evaluation of activities occurs in 1 calendar minute intervals and the DTCO 4.1x will evaluate the longest continuous activity for each interval.

- The DTCO 4.1x can store approx. 168 hours of speed values in the resolution of one second. Each second of the values is thus saved exactly with date and time.
- Saved speed values with a high resolution (one minute before and one minute after an unusual deceleration) support the analysis in the event of an accident.

This data can be read via the front interface (only with company card):

- Downloading the driver card data.
- Downloading the mass memory with a download key (option).

■ Border crossing

The DTCO 4.1x automatically recognises a border crossing.

This applies for all countries of the NUTS0 map: <https://ec.europa.eu/eurostat/documents/345175/7451602/2021-NUTS-0-map.pdf>.

The Spanish regions are also automatically detected.

Where a country is not stored on the NUTS0 card, it must be entered manually → *Indicating the country at start of shift* [57].

For second-generation driver cards, Version 2, border crossings are saved automatically.

The vehicle unit of the DTCO 4.1x will store border crossings for 365 days.

■ Time zones

The DTCO 4.1x factory time setting is UTC time.

Time entries are stored by the DTCO 4.1x in UTC time.

The UTC time corresponds to time zone 0 on earth's 24 time zones (−12...0...+12h).

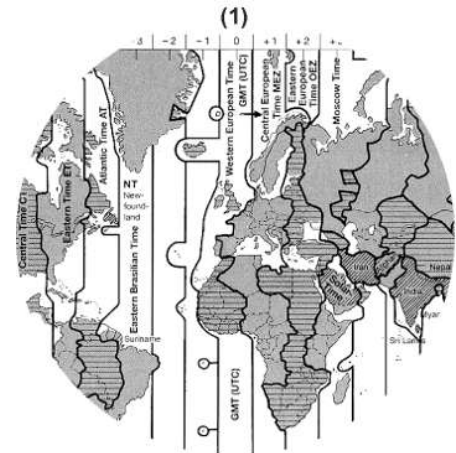

Fig. 4: Time zones in Europe

(1) Time zone 0 = UTC

Time zone difference	Country
00:00 (UTC)	UK / P / IE / IS
+ 01:00 h	A / B / BIH / CZ / D / DK / E / F / H / HR / I / L / M / N / NL / PL / S / SK / SLO / SRB
+ 02:00 h	BG / CY / EST / FIN / GR / LT / LV / RO / UA
+ 03:00 h	RUS / TR

Converting to UTC time

UTC time = Local time – (ZD + SO)

ZD = time zone difference

SO = summer time (only during summer time)

(ZD + SO) = time difference to be set

Example:

Local time in Germany = 15:30 (day-light-savings time)

UTC time = Local time – (ZD + SO)
= 3.30 p.m. – (01:00 h + 01:00 h)

UTC time = 1.30 p.m.

In this menu, you can set the local time:

➔ *Set Local time* [▶ 100]

■ Pictograms (overview)

Operating modes	
🏢	Company
🚦	Control
⚙️	Operation
🔧	Calibration
🏭	Production status

Persons	
🏢	Company
🚦	Controller
👤	Driver
🔧	Workshop / inspection centre
🏭	Manufacturer

Activities	
🛑	Standby time
🕒	Driving time
🛑	Break and rest time

Activities	
⌘	Other working time
⏸	Valid interruption / break
?	Unknown

Devices / functions	
1	Card drawer 1; driver 1
2	Card drawer 2; driver 2
📠	Tachograph card (read correctly)
📠	Tachograph card inserted, relevant data read
🕒	Clock
🖨	Printer / printout
👉	Entry
📺	Display
📄	Licence code
📁	External storage; downloading data (copying)
📡	Data transmission running
📡	Sensor

Devices / functions	
🚗	Vehicle / vehicle unit / DTCO 4.1x
🛞	Tyre size
⚡	Low voltage
⚡	Overtoltage
⚡	Voltage interruption
📶	Remote control
📶	GNSS
📶	DSRC
📶	ITS
📶	Toll
🚛	Total weight of vehicle group, trailer included

Miscellaneous	
!	Event
×	Malfunction
📄	Operational note / Working time warnings
📄	Shift start

3







Miscellaneous	
✦	Location
🔒	Safety/ authentication
➤	Speed
🕒	Time
Σ	Total / summary
⏸	End of shift
📝	Manual entry of activities
🚧	Border crossing
📊	Graph
⚖	Difference
👤	User entry
⌚	Please wait
ℹ	Information
📶	Remote HMI
📶	Bluetooth
🚗	In vehicle connection





Specific conditions	
OUT	Recording equipment not required
🚢	Vehicle located on a ferry or on a train
👤	Standard load: Passengers
📦	Standard load: Goods
❓	Standard load: unspecified
➤	Load
📦	Unload
🚗	Simultaneous load/unload



Qualifiers	
24h	Daily
I	Weekly
II	Two weeks
+	From or to















Pictogram combinations

Miscellaneous	
📍	Control location
🕒	Start time
🕒	End time
OUT+	Start "Out of scope": Recording equipment not required
+OUT	End "Out of scope":
🚢+	Start "ferry / train".
+🚢	End "ferry / train"
🕒📊	Position after 3 h accumulated driving time
➤📊	Position "load"
📦📊	Position "unload"
🚗📊	Position simultaneous "load"/ "unload"
🚧📊	Position border crossing
✦🕒	Location at start of working day (shift start)
🕒✦	Location at end of working day (shift end)
🚗+	From vehicle















Miscellaneous	
	Printout driver card
	Printout vehicle / DTCO 4.1x
	Entry vehicle / DTCO 4.1x
	Display driver card
	Display vehicle / DTCO 4.1x
	Local time
	Local time company















Cards	
	Driver card
	Company card
	Control card
	Workshop card
	No card inserted



Driving	
	Crew operation
	Total driving time of double weeks







Printouts	
24h 	Daily driver activities (daily value) from the driver card
!x 	Events and faults from the driver card
24h 	Daily driver activities (daily value) from DTCO 4.1x
!x 	Events and faults from DTCO 4.1x
>> 	Speeding events
T 	Technical data
il 	Driver activities
iR 	Periods with activated remote control
ilv 	v-diagram
ilD 	Status D1/D2 diagram (option)
%v 	Speed profiles (option)
%n 	Rpm profiles (option)
iL 	Sensor information
i 	Safety information

3

Displaying	
 	Daily driver activities (daily value) from the driver card
 	Events and faults from the driver card
 	Daily driver activities (daily value) from vehicle / DTCO 4.1x
 	Events and faults from the vehicle/ DTCO 4.1x
	Speeding events
	Technical data
	Cards
	Company
	Last measured total weight of vehicle group, trailer included
	Permitted total weight of vehicle group, trailer included

Events	
	Insertion of an invalid tachograph card
	Time overlap
	Insertion of driver card while driving
	Speeding
	Motion data error
	Time adjustment (by workshop)
	Card conflict
	Driving without valid driver card
	Last card process not completed correctly
	Interruption of the power supply
	Security breach
	Missing GNSS signal
	GNSS irregularities
	Time conflict
	Communication error DSRC

Events	
	Speeding control
	Vehicle motion conflict

Malfunctions	
	Card fault
	Printer fault
	Internal fault DTCO 4.1x
	Download fault
	Sensor malfunction
	Internal GNSS fault
	Internal DSRC fault

Driving time warnings	
	Break!

Manual entry process	
☒/☒/☒	Entry of "activities"
?	Entry of "unknown activity"
☒+?	Entering <i>location</i> at the end of the shift
+☒?	Entering <i>location</i> at the start of the shift

Operational notes	
☒	Wrong entry
☒	Menu access not possible
☒↘	Please enter
☒☒	Printout not possible
☒☒○	No paper
☒☒☒	Printout delayed
☒	Faulty card
☒☒c	Eject the card
☒	Incorrect card
☒	Ejection not possible
☒☒☒	Process delayed
☒☒?	Recording inconsistent

Operational notes	
☒	Internal fault
☒☒1	Invalid in days ...
☒☒☒	Calibration in days ...
☒☒☒1	Downloading data from the driver card in days ...

VDO Counter (option)	
☒☒	Remaining driving time
☒☒	Start of the next driving time
☒☒☒	Future driving time
☒☒	Remaining break time / rest time
+☒	Remaining time to start, daily, weekly rest time

■ Country symbols

Country abbreviations	
A	Austria
AL	Albania
AND	Andorra
ARM	Armenia
AZ	Azerbaijan
B	Belgium
BG	Bulgaria
BIH	Bosnia and Herzegovina
BY	Belarus
CH	Switzerland
CY	Cyprus
CZ	Czech Republic
D	Germany
DK	Denmark
E	Spain *
EC	European Community
EST	Estonia
EUR	Rest of Europe

3

Country abbreviations	
F	France
FIN	Finland
FL	Liechtenstein
FR/FO	Faroes
GE	Georgia
GR	Greece
H	Hungary
HR	Croatia
I	Italy
IRL	Ireland
IS	Iceland
KZ	Kazachstan
L	Luxembourg
LT	Lithuania
LV	Latvia
M	Malta
MC	Monaco
MD	Republic of Moldavia
MK	Macedonia
MNE	Montenegro

Country abbreviations	
N	Norway
NL	The Netherlands
P	Portugal
PL	Poland
RO	Romania
RSM	San Marino
RUS	The Russian Federation
S	Sweden
SK	Slovakia
SLO	Slovenia
SRB	Serbia
TJ	Tajikistan
TM	Turkmenistan
TR	Turkey
UA	Ukraine
UK	United Kingdom, Alderney, Guernsey, Jersey, Isle of Man, Gibraltar
UZ	Uzbekistan
V	Vatican City

Country abbreviations	
WLD	Rest of the world

* Spanish regions: → *Spanish regions*
[▶ 41]

► Spanish regions

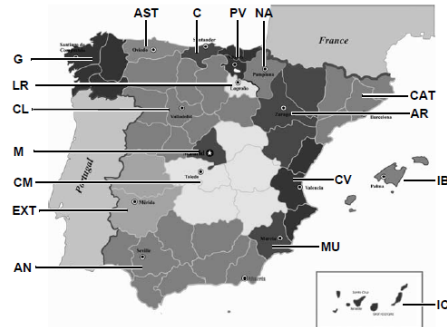

Fig. 5: Regions in Spain

Identifications of the Spanish regions

AN	Andalusia
AR	Aragon
AST	Asturias
C	Cantabria
CAT	Catalonia
CL	Castile-León
CM	Castile-La Mancha
CV	Valencia
EXT	Extremadura
G	Galicia
IB	Balearic islands
IC	Canary Islands
LR	La Rioja
M	Madrid
MU	Murcia
NA	Navarra
PV	Basque Community

■ Automatic activities after ignition on/off (default)

Automatically set activity:

After ignition on

Driver 1 and driver 2

⌂	Break time / rest time
*	Other working time
☑	Standby time
?	No change

After ignition off

Driver 1 and driver 2

⌂	Break time / rest period
*	Other working time
☑	Standby time
?	No change

IMPORTANT

The vehicle manufacturer may have already programmed defined settings of the activity after *ignition on/off*.

- Mark the set functions in the table by (√).

IMPORTANT

An exception is the addition of activities on the driver card. This option is disable during *Manual input*. There is no change of activity after *ignition on/off*.

The automatic setting after "*ignition on/off*" is visible in the standard display. The activity flashes for approx. 5 seconds and subsequently, the previous display reappears.

→ *Displays* [44]

Standard settings:

→ *Setting activities* [59]

Operation (general)

Displays

Navigating within menus

Inserting card

Removing the card

Handling of the cards

Downloading data

4

Operation (general)

■ Displays

► Display after ignition on

If no tachograph card is inserted into card drawer 1, for 20 seconds, note (1) (H ■ card! H) is displayed, afterwards display (2).

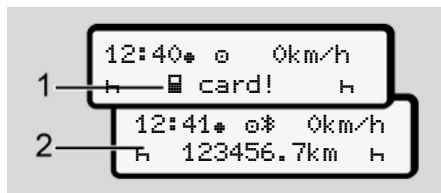

Fig. 6: Display after ignition on

IMPORTANT

Explanation of the pictograms → *Displays during journey* [▶ 44]

► Displays during journey

While driving, the displays (a), (b) or (c) (option) can appear.

Complete listing of the pictograms → *Pictograms (overview)* [▶ 35].

By pressing a menu button / you can change the display.

Displays during journey:

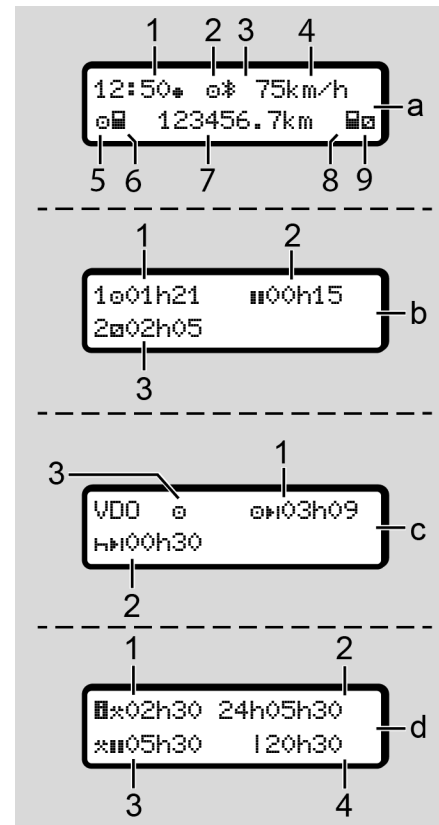

Standard display (a):

- (1) Time
with symbol \ast = local time
without symbol \ast = UTC time
- (2) "Operating mode symbol "Operational"
- (3) Symbol that Bluetooth is active
- (4) Speed
- (5) Activity driver 1
- (6) Card symbol driver 1
- (7) Odometer total
- (8) Card symbol driver 2
- (9) Activity driver 2

Display driving and rest times (b):

- (1) Driving time \odot driver 1 since a valid rest time
- (2) Valid rest time \equiv in break intervals of at least 15 minutes and subsequent 30 minutes
- (3) Times of driver 2:
Current activity availability time \boxtimes and duration of activity.

IMPORTANT

If no driver card is inserted, times are displayed that are assigned to the respective card drawer 1 or 2.

Display remaining driving and rest times (option VDO Counter) (c):

- (1). Remaining driving time $\odot\ast$:
(\ast flashes = this part of the display is currently active)
- (2) Next valid rest time/ daily or weekly rest time $\equiv\ast$:
→ VDO Counter (option) [► 81]
- (3) The current activity is displayed

Working time counter display (option VDO counter) (d):

- (1). Uninterrupted working time: (period of the currently set working time ✖ without rest time)
- (2). Daily working time: (total working time since the last daily or weekly rest time)
- (3). Accumulated rest time: (total rest time during the current working time ■■)
- (4). Current weekly working time: (total currently set working time for the current calendar week up to the present time)

► Messages

Messages are displayed independently of the current activity.

The following causes result in a message being displayed:

!	Event
×	Malfunction
⏸	Driving time warning
ℹ	Operating note

➔ *Meaning of messages* [▶ 109]

► Display after ignition off

After “ignition off”, the following is displayed:

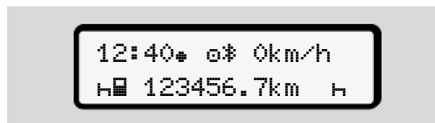

Fig. 7: Display after ignition off

■ Navigating within menus

- Select the desired function, activity or numeric value with the keys **▲** **▼** in the entry field.
- Confirm your selection with the button **OK**.

► Menus while vehicle is stationary

When the vehicle is not moving and driver card is inserted, you can call up other data of the driver card.

➔ *Second menu level – menu functions* [▶ 87]

■ Inserting card

⚠ ATTENTION

Ensuring road safety

- As a driver, only insert the card while the vehicle is stationary.
- Inserting the card while the vehicle is moving is possible but not permitted. This is saved as an event.

Always keep the card drawers closed.

The card drawer covers must not be removed to prevent dust and dirt or spray water getting into the card drawer.

IMPORTANT

Selection of the card drawer

- Card drawer 1 (left card drawer) for the card of the person driving the vehicle.
- For crew operation: Card drawer 2 (right drawer) for the card of the accompanying driver.
- For the company card: Freely selectable card drawer.

IMPORTANT

For operating the ADR variant, the ignition must be switched on.

Please observe the special safety notes for the operation of the ADR variant of the DTCO 4.1x in explosive environments.

→ *ADR version (Ex version)* [▶ 25]

1. Keep the combination button driver 1 or driver 2 pressed for more than 2 seconds.



Fig. 8: Request card (combination button)

2. The card drawer comes out. Carefully fold down the card drawer cover.



Fig. 9: Fold down the cover

3. Insert your card – chip up and arrow facing forward – into the card drawer.



Fig. 10: Inserting card

4. Carefully fold up the card drawer cover.
5. Push the card drawer into the card drawer until it engages. The information on the chip is read.

While a card is being read in card drawer 1, another card can be inserted into card drawer 2:

- Crew operation: the driver card of the second, accompanying driver.
- Reading the card and mass memory data: the company card.

Depending on the card inserted, menu-driven operation steps are carried out.

- For the first and (if inserted) second driver card
→ *Shift start – Inserting driver card* [▶ 53]
- For the company card
→ *Registration – inserting company card* [▶ 72]

IMPORTANT

If, when reading a card, the DTCO 4.1x determines that the card is invalid, the reading process is aborted (1/1 insertion aborted).

► Language

The language displayed depends on:

- Card inserted into card drawer 1.
- The tachograph card with a higher value, such as the company card or control card.

As an alternative to the automatic language setting, you can set the desired language.

→ *Setting the language* [▶ 81]

■ Removing the card

IMPORTANT

You must only remove the cards when the vehicle is stationary.

⚠ ATTENTION

Protection from misuse

Remove the driver card from the card drawer:

- At the end of the shift
- When changing drivers or vehicles

IMPORTANT

For operating the ADR variant, the ignition must be switched on.

Please observe the special safety notes for the operation of the ADR variant of the DTCO 4.1x in explosive environments.



→ *ADR version (Ex version)* [▶ 25]



Fig. 11: Request card (combination button)

1. Keep the combination button Driver 1 or Driver 2 pressed for more than 2 seconds.

Subsequently, the display will show:

- The name of the card owner.
 - A progress bar for the transmission of data onto the card chip.
 - The logoff request.
2. Use the buttons  /  to select the desired function:
 - Driver card:
Selection of the country you are currently in.

IMPORTANT

If the country is not entered within a minute, the card ejection is terminated.

- Company card:
 - Yes if you wish to log off the company on the DTCO 4.1x.
 - No if the company lock should stay activated.

IMPORTANT

If the company lock is deactivated, the saved data of your company will still be locked for an external company.

3. Please confirm your selection using the button .

IMPORTANT

A note is displayed for the following cases:

- Periodic verification of the DTCO 4.1x
- Validity of the company or driver card expires
- Download of data on the driver card is due

IMPORTANT

If an inserted card is currently being processed (for reading or ejection) and the ejection of a card in the other card drawer is requested then the DTCO 4.1x first completes the current process of the first card before the ejection process for the second card is started.

The card feed of the corresponding drawer comes out

4. Remove the card.
5. Carefully fold up the card drawer cover.
6. Push the card drawer into the card drawer until it engages.

■ Handling of the cards

- Do not bend or fold the tachograph card and do not use them for anything other than their intended purpose.
- Do not use damaged tachograph cards.
- Keep all contact surfaces clean, dry, and free of grease and oil (always use a protective cover).
- Protect the card from direct sunlight (do not leave it lying on the instrument panel).
- Do not place it in direct proximity to strong electromagnetic fields.
- Do not use the card beyond its period of validity. Apply for a new tachograph card in a timely manner before expiry.

■ Downloading data**▶ From driver or company card****RISK OF EXPLOSION!****Explosion risk due to residual voltage and open interfaces for the ADR variant**

Operating the buttons of the DTCO 4.1x, inserting cards, opening the printer drawer or opening the front interface, poses an increased explosion risk in explosive areas.

- The cover must be closed.
- No data may be downloaded.

IMPORTANT

Only 1 driver card (card of driver-1 or driver-2) may be inserted for downloading.

If both cards are inserted, no data transmission will occur.

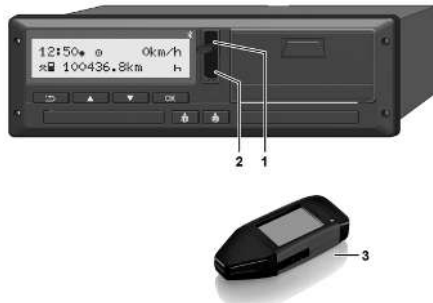

Fig. 12: Connecting to the front interface

1. Fold up the cover flap (1) of the front interface.
2. Insert the download key (3) into the front interface (2).
The download starts automatically.

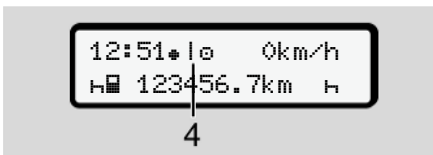

Fig. 13: Pictogram: Data transfer

During the data transfer, the corresponding pictogram (4) is displayed.

IMPORTANT

Possible loss of data during the transfer onto the download key.

Do not interrupt the connection to the front interface during the data transfer.

3. Please close the cover flap (1) after downloading the data.

► Data identification

The copied data is assigned a digital signature (identification).

This signature allows to assign the data to a specific driver card and to check its completeness and authenticity.

IMPORTANT

Detailed information about the readout software or the download key is included in the corresponding documentation.

► Downloading from the mass memory

Data can only be downloaded from the mass memory with the company card.

You can set on the download key which data (card or mass memory) is to be downloaded.

► Remote-controlled download (option)

A fleet management system (remote operation) also enables a remote-controlled download of the data after successful authentication of a company card.

IMPORTANT

Detailed information about the hardware and software components required for this as well as their usage is included in the corresponding documentation.

Operation by the driver

Driver card functions

Shift start – Inserting driver card

Setting activities

Load/unload (cabotage)

Shift end – removing driver card

Manual entries (entry/addition)

Driver / vehicle change

Inserting driver card for the first time

Operation by the driver

■ Driver card functions

The driver card is used by the driver to identify himself on the DTCO 4.1x.

The driver card is used for normal driving operation and allows storing, displaying, printing or downloading (with the driver card inserted) of activities.

IMPORTANT

The driver card is not transferable.

IMPORTANT

Menus for the display and the printout of driver data are only available if a corresponding card is inserted.

For example, menu point `Printout` `driver 2` is only displayed when a driver card is inserted in card drawer-2.

■ Shift start – Inserting driver card

IMPORTANT

“*Operation by driver*” corresponds to operating mode “*Operational*” according to Implementation Regulation (EU) 2016/799 I C, as amended.

→ *Operating modes (overview)* [▶ 27]

IMPORTANT

For operating the ADR variant, the ignition must be switched on.

Please observe the special safety notes for the operation of the ADR variant of the DTCO 4.1x in explosive environments.

→ *ADR version (Ex version)* [▶ 25]

▶ 1. Inserting card

At the start of your shift (start of your workday), insert your driver card into the card drawer.

→ *Inserting card* [▶ 47]

- Inserting the driver card switches the display to the language stored on the driver card.

IMPORTANT

You can set the language in the menu.

→ *Setting the language* [▶ 81]

The menu displayed guides you step by step to the complete operational readiness of the DTCO 4.1x:



Fig. 14: Welcome display

5

The name of the cardholder, the set local time (e.g. 16:00*) and the UTC time (e.g. 14:00UTC) will appear for approximately 3 seconds (time offset = 2 hours in summer time).

Entries are not possible while the card is being read.

When a button is pressed, a message is displayed:

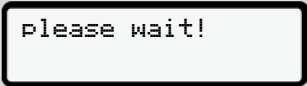

please wait!

Or rather:

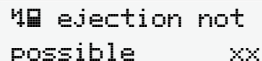

E E ejection not possible xx

The card information is being read:



b. 10 Maier
----- 0

Fig. 15: Reading the card information

The left side displays the number of the card drawer into which the card is inserted.

Next to it appears the name of the driver (read by the driver card).

A progress bar displays the continued of the driver card.

IMPORTANT

As long as the manual entry of driver activities is possible, but not yet started, the DTCO 4.1x offers the driver the possibility to eject this driver card without further storing of data records on the card and DTCO 4.1x.

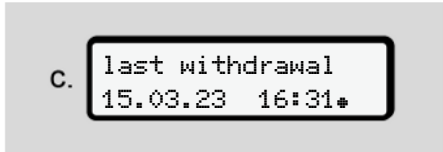

c. last withdrawal
15.03.23 16:31*

Fig. 16: Display of the last removal

For approx. 4 seconds, date and time of the last card removal are displayed in local time (symbol *).

IMPORTANT

Pay attention to the completeness of the driver data.

According to the Regulation, any activities which cannot be recorded on the driver card must be entered manually.

Next follows the request for manual addition:

d. 1M entry
addition? No
addition? yes

Fig. 17: Addition as option

- You can add activities;
→ *Manual entries (entry/addition)*
[▶ 63]
- If you do not want to add “any activities”, select **No**; to continue, see step i.
- By selecting **Yes** you request DTCO 4.1x to make manual inputs; subsequent display:

e. M 15.03.23 16:31
H 18.03.23 07:35

Fig. 18: Entry options

M = Manual entry

H = Entry field of the activity is flashing

The period between removal (1st line) and current insertion-withdrawal operation (2nd line) in local time appears.

→ *Setting activities* [▶ 59]

f. M 15.03.23 16:31
H 16.03.23 07:35
H 16.03.23 09:35

Fig. 19: 2nd row = entry block

- You can enter the required information (flashing entry fields) in the following order: *Activity / Day / Month / Year / Hour / Minute*.

The process ends when the time of the insertion-withdrawal operation is reached.

IMPORTANT

The DTCO 4.1x rejects the withdrawal of driver card until the reading procedure is finished. You have to request the

withdrawal again to withdraw the driver card after the DTCO 4.1x has finished the reading procedure.

Next, the prompt for entering the country appears.

g. *|> besin country
:E
*|> besin region
E AN

Fig. 20: Selecting the country

- Select the country and region, if necessary applicable, for which the addition is for and confirm your selection with **OK**.
→ *Country symbols* [▶ 39]

IMPORTANT

For Spain, you must also state the region.

5

IMPORTANT

You can press the button  to terminate the entry if you would like to continue your shift immediately.

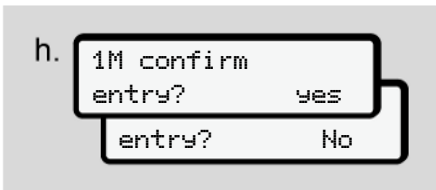

Fig. 21: Confirming the entry

- Please confirm your entry with Yes or No.

IMPORTANT

When selecting No, the entries are displayed again and you can correct them, if necessary.

- First insertion
The first time the driver card is inserted, additional prompts are displayed:
→ *Inserting driver card for the first time* [68]

The standard display follows.

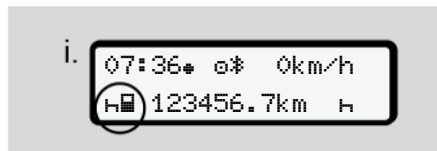

Fig. 22: Standard display with inserted card

The symbols displayed have the following meaning:

- _ = The driver card is in the card drawer.
- = You can start the journey, the data is read.

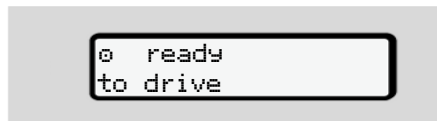

Fig. 23: Ready for driving

The DTCO 4.1x indicates that the journey can start, also whether it is a single driver (0) or a crew operation (00).

IMPORTANT

If the readiness to drive is not displayed, check whether a valid driver card has been inserted in drawer 1 and drawer 2, all necessary information has been carried out and there is no card conflict.

IMPORTANT

If two driver cards are inserted, the DTCO 4.1x requests the entries for the second driver card as soon as the first driver card has been read and readiness to drive has been displayed.

IMPORTANT

The symbol ■ is displayed for both card drawers.

If the cards are inserted for driver 1 and driver 2, the journey can commence as soon as the symbol ■ is displayed for driver 1.

▶ 2. Setting activity

Use the combination button of the corresponding card drawer **OK** to set the activity you would like to perform.

→ *Setting activities* [▶ 59]

- When changing the local time: Adjust the time to the current local time.
→ *Set Local time* [▶ 100]

The DTCO 4.1x is ready.

IMPORTANT

The start of the journey ends any started manual entry – also for driver 2.

⚠ ATTENTION

It is essential that you set the activity to **H** during a break or rest time.

Faults on the DTCO 4.1x or the system components are shown in the display → *Meaning of messages* [▶ 109].

- Confirm the message with the button **OK**.

▶ Country entry – manual

A border crossing is automatically detected by the DTCO 4.1x → *Border crossing* [▶ 33].

If the DTCO 4.1x does not automatically detect the border crossing, the country change must be performed manually:

Indicating the country at start of shift



Fig. 24: Entry option – start country

- Select the **•H? bes. country** symbol and confirm.
- Selecting country and confirming.
→ *Country symbols* [▶ 39]

IMPORTANT

In Spain, you must also indicate the region in which your journey commences.
→ *Spanish regions* [▶ 41]

Indicating country at shift end

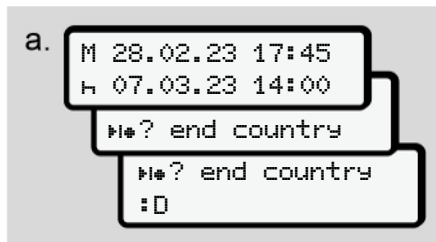

Fig. 25: Entry – End country

- In the first entry field **H**, select the symbol **•H? end country** and confirm.
- Select and acknowledge the country.

5

Selecting the countries

- **Manual addition**
In case of a manual addition, the 4 countries entered last are displayed via the **▲** / **▼** buttons.
Marking: Colon in front of the country symbol **⌚B**.
- **Current time**
For the current time, the country last available via GNSS is displayed.
Marking: Colon in front of the country symbol **⌚B**.

IMPORTANT

This is also available for the region selection – e.g Spain.

The subsequent selection occurs in alphabetical order, starting with letter **A**:

- Button **▲**: A, Z, Y, X, ... and more
- Button **▼**: A, B, C, D, ... and more

IMPORTANT

If vehicle recording is activated, the DTCO 4.1x offers a pre-selection of countries based on the location of the vehicle at the time the driver card was inserted.

If a country cannot be determined by the vehicle recording (vehicle is outside the available card data or the position calculation is still running), the DTCO 4.1x offers the last four specified countries or regions.

IMPORTANT

By pressing and holding of button **▲** / **▼** you can accelerate the selection (auto repeat function).

IMPORTANT

The suggested locations are suggestions to make the selection easier. As the driver, ensure that you select the country you are actually in.

► Aborting the entry procedure

If no entry occurs within 30 seconds, the following display is shown:

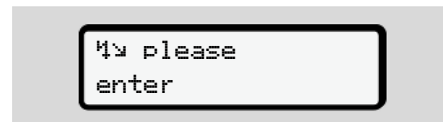

Fig. 26: Entry request on the display

If within a further 30 seconds the button **OK** is pressed, you can continue the entry.

The driver card is ejected when no entry is made and no button is pushed on the DTCO 4.1x within 10 minutes.

Data already entered but not yet confirmed is discarded to ensure that only correct data and data confirmed by you is stored. This affects the remote entry and the direct entry in the DTCO 4.1x.

Requesting the card by pressing the combination button **⏏** interrupts the "manual entry". This is also cancelled if the journey is started during the entry.

■ Setting activities

► Possible activities

The following activities can be set:

⊖	Driving time (automatic when driving)
*	All other working times
⊠	Availability (waiting times, co-driver time, driver 2 sleeper-cab time during the journey)
⌂	Breaks and rest times

► Changing activities

IMPORTANT

Setting the activities is only possible when the vehicle is stationary.

- Press the combination button  for driver 1.
The standard display is shown.

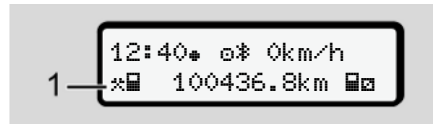



Fig. 27: Standard display with activity (1)

- Press the combination button  until the required activity appears in the display (1).
- In crew operation: As co-driver (driver 2), press button .

► Automatic setting

The DTCO 4.1x switches automatically to the following activities:

for ...	Driver -1	Driver -2
Journey	⊖	⊠
Vehicle stop	*	⊠

IMPORTANT

Ensure the correct calculation of the VDO Counter (option):

- It is essential that you set activity \lrcorner at the end of a shift or break.

Automatic setting after ignition on/off (default)

After ignition on/off, the DTCO 4.1x can switch to a defined activity; for example \lrcorner .

This activity can be programmed with a company card or by an authorised specialist workshop.

5

The activity (1) and/or (2), which automatically changes due to ignition on or ignition off, is shown in the standard display. It flashes for around 5 seconds.

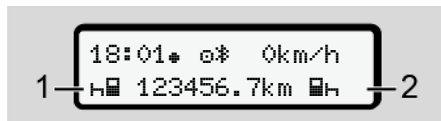

Fig. 28: Flashing of the activity in the standard display

After ignition on, the previous display reappears.

Example:

You have selected the “Counter” and are switching the ignition off. When switching on the ignition, the “Counter” is displayed again “after 5 seconds.

► Recording activities manually

IMPORTANT

Observe Regulation.

According to Regulation (EU) 165/2014, activities which cannot be recorded on the driver card must be added manually.









In the following cases, activities must be entered in writing:

- In case of a defect in the. DTCC 4.1x.
- In case of loss, theft, damage or malfunction of the driver card.

In these cases, you must create a daily printout on the DTCC 4.1x at the start and at the end of the journey or the shift.

On the back of the printout, you can add your activities manually (2) and complete the printout with personal details (1).

Fig. 29: Entering the activities

Meaning of symbols	
	First and last name
	Number of the driver card or the driving licence
	Vehicle registration number
	Location at the start of the shift
	Location at the end of the shift
	Odometer reading at the end of the shift
	Odometer reading at the start of the shift
	Kilometres travelled

IMPORTANT

Please observe the legal requirements applicable in your country.

■ Load/unload (cabotage)

You can document loading/unloading processes within the cabotage regulation (cross-border transport) in the DTCO 4.1x.

The DTCO 4.1x stores the location and time of a loading/unloading process.

Entry menu: → *Menu point entry vehicle* [▶ 99]

■ Shift end – removing driver card

IMPORTANT

To protect personal data, you should remove your driver card at the end of each shift.



You can only remove the driver card when the vehicle is stationary.

IMPORTANT

To operate the ADR version, the ignition must be switched on.

Please observe the special safety notes for the operation of the ADR version in explosive environments.

→ *ADR version (Ex version)* [▶ 25]

1. At the end of your shift (end of your working day) or when changing vehicles, set the corresponding activity, e.g. rest time .
→ *Setting activities* [▶ 59]
2. Press the button  for at least 2 seconds.

5



Fig. 30: Details to the current location

- Choose the country with the buttons **▲/▼** and confirm the selection with button **OK**.
→ *Indicating the country at start of shift* [▶ 57]

IMPORTANT

As soon as the function is available, the DTCO 4.1x offers the possibility to generate a daily printout before the card is ejected.

IMPORTANT

If the country is not entered within a minute, the card ejection is terminated.

- The number of the card drawer and the driver's surname are displayed. A status bar shows the writing process of the driver card.
- Remove your driver card from the card drawer.
→ *Removing the card* [▶ 49]
This also applies for driver changeovers in crew operation. Next, insert your driver card into the other drawer.
The display shows:



Fig. 31: Standard display without cards

- If required, use the print menu to print out the saved activities and events.
→ *Second menu level – menu functions* [▶ 87]

IMPORTANT

If you would like a printout of the past 24 hours, please wait – if possible – until the following day.

This way, you ensure that the last activity is also fully included in the printout.

■ Manual entries (entry/addition)

If, after inserting the driver card, you confirmed the prompt `1M entry addition? yes` with `Yes` (step d), the manually changeable entries are displayed (step e).

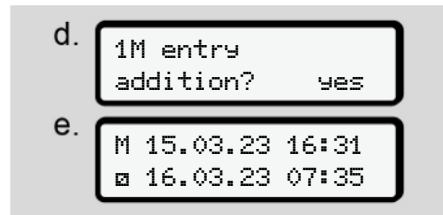

Fig. 32: Displays of correction options

You can only make the entries one after the other (buttons `▲/▼` and `OK`).

If you made an incorrect entry, you can go back using the button `⏪` and repeat the entry.

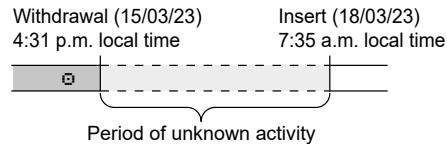

Fig. 33: Example for a period with unknown activity

The following entries are possible:

- Activity rest time `H` add:
→ *Adding activity rest time* [▶ 64]
- Continue working time:
→ *Continuing activities* [▶ 65]
- Continue working time, end working time and/or precede a working time with activities:
→ *Continuing activities and preceding others with activities* [▶ 66]

These options after inserting your driver card also generally apply for selecting the current activity.

▶ Card requests during the manual entry

1. Use the button `⏪` to request the card for ejection.
The prompt for manual entry is displayed:

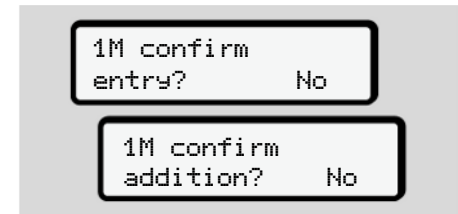

Fig. 34: Addition as option

2. Use the buttons `▲/▼` to select `No` and confirm with button `OK`.
3. Continue with step 3.
→ *Shift end – removing driver card* [▶ 61]

The manual entry is aborted. The DTCO 4.1x stores the activity `?` for the unknown period.

5

► Adding activity rest time

Withdrawal (15/03/23) 4:31 p.m. local time	Insert (18/03/23) 7:35 a.m. local time
---	---

Add rest period

Observe: Entry takes place in local time.

- a. After selecting **Yes** for an addition:
- b. Select and confirm the activity **H** using button **OK**.
The display moves to the next flashing entry field. If you keep the button **OK** pressed, the display moves to the last entry of the display.
- c. Also confirm the last entry of the minutes using button **OK**.
- d. Follow the menu guidance.

► Continuing activities

Withdrawal (24/03/23) 11:32 p.m. local time

Insert (25/03/23) 2:30 a.m. local time

00:20 a.m. local time

Add activities

Observe: Entry takes place in local time.

- Select and confirm that first activity * using button **OK**.
- Enter first the day and then the time and confirm both using button **OK**.
- Select and confirm the second activity a using button **OK**.
- Again, enter day and time and confirm using button **OK**.
- Also confirm the last entry of the minutes using button **OK**.
- Follow the menu guidance.

5

► Continuing activities and preceding others with activities

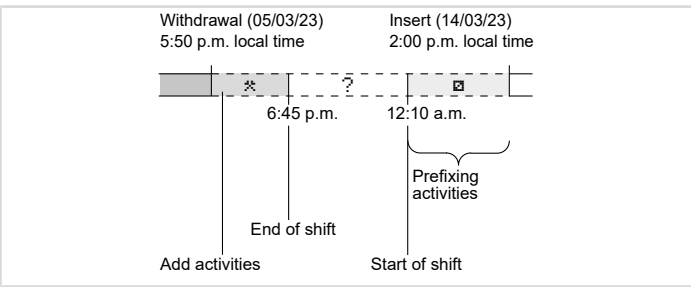
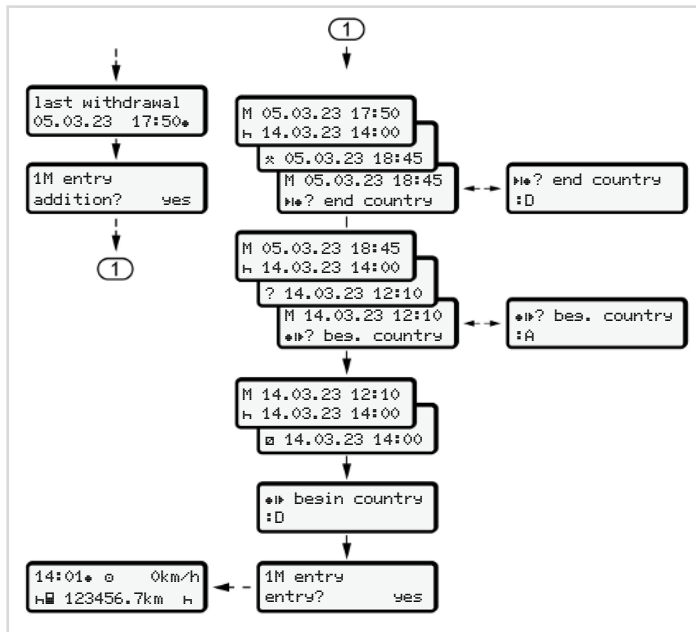

- Observe: Entry takes place in local time.
- a. Select and confirm the first activity * with date and time.
 - b. Select and confirm the H? end country symbol.
 - a. Select and confirm the country.
 - b. Select and confirm the following activity
? = unknown activity with date and time.
 - c. Repeat steps 2 to 4 until the time of the insertion-withdrawal operation has been reached.

■ Driver / vehicle change



Fig. 35: Changing driver card

► Case 1 – Crew operation

Driver-2 becomes Driver-1.

- a. Removing driver cards from the card drawers and insert into the other card drawer.
- b. Setting required activity:
→ *Setting activities* [▶ 59].

IMPORTANT

During crew operation, the card of driver 1 can be inserted first in order to be able to start the journey quickly. While the card of driver 1 is read, the card of driver 2 can be inserted.

The journey can be started as soon as the symbol ■ for driver 1 and the symbol ■ for driver 2 is displayed.

► Case 2 – Shift end

Driver 1 and/ or driver 2 leave the vehicle.

- a. The person in question creates a daily printout, if necessary, requests his driver card and removes the driver from the card drawer.
- b. The new vehicle crew inserts the driver card, depending on the function (driver 1 or driver 2) into the card drawer.

► Case 3 – Mixed operation

Vehicle usage with different tachograph types.

- For example, analogue tachographs or ...
- digital tachograph with driver card according to Regulation (EU) 165/2014, for example DTCO 4.1x.

During an inspection, the driver must be able to present the following items for the current week and for the last 28 days:

- Driver card **(1)**,
- relevant daily printouts from the digital tachograph **(2)**, for example in the event of damage or malfunction of the driver card,
- filled in charts **(3)**,
- manual records of the activities.

5

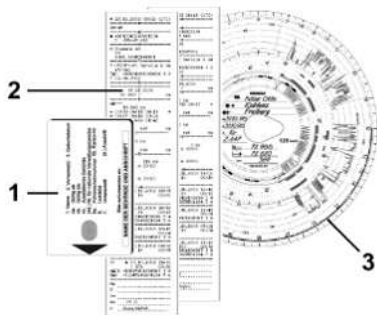

Fig. 36: Examples of documents to be carried

IMPORTANT

Please observe the legal requirements applicable in your country.

■ Inserting driver card for the first time**▶ Data usage**

When you insert your driver card for the first time, you will be asked about the protection of your personal data and whether you agree to the processing of personal data.

→ *Data protection* [▶ 9]

▶ Registration process

The prompt occurs automatically during the first registration in the DTCO 4.1x.

It occurs after selecting the country.

IMPORTANT

You can change the entries afterwards:
→ *Menu point Entry driver 1/driver 2* [▶ 95]

Release ITS Data**IMPORTANT**

To activate Bluetooth, you must have consented to the storage of the ITS data (→ *Personal ITS data* [▶ 10]).

```
1 publish
ITS data?  yes
```

Fig. 37: Retrieval of personal data

1. Use the buttons / to select Yes or No.
2. Acknowledge with the button . A message about the storage of the entry is displayed:

```
entry stored
```

Fig. 38: Save confirmation

Release VDO Data

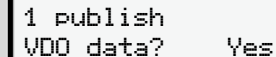

```
1 publish
VDO data?  Yes
```

Fig. 39: Retrieval of personal special data

3. Use the buttons **▲**/**▼** to select **Yes** or **No**
4. Acknowledge with the button **OK**.
A message about the storage of the entry is displayed:

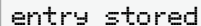

```
entry stored
```

Fig. 40: Confirmation of second save

Activate Bluetooth

Activating Bluetooth can be carried out in this menu or later in the “Bluetooth” menu:

The description of the activation can be found here: → *Bluetooth pairing* [▶ 97]

Completing the registration

Next follows the normal registration on the DTCCO 4.1x.

→ *Shift start – Inserting driver card* [▶ 53]

Operation by the contractor

Functions of the company card

Menu functions in the company mode

Registration – inserting company card

Inserting member state and vehicle registration number

Removing company card

Operation by the contractor

■ Functions of the company card

IMPORTANT

The company card is used solely for the data management of the company, not for driving operations.

If you are driving with the company card, the message ! driving without card xx is displayed.

IMPORTANT

Observing the country requirements.

The company ensures the correct use of the company cards.

- Please observe the legal requirements applicable in your country.

The company card is used to identify a company in the DTCO 4.1x.

The company card is proof of the correct operation of the vehicle. The company card is used to assign the respective vehicle to the company in respect of all relevant data.

The company can request several company cards.

Independent of the drivers, the mass memory of the tachograph stores all vehicle movements and times.

The company is legally obliged to store this data and to make it accessible to the relevant supervisory authorities upon request.

The company card is valid for 5 years. A follow-on card can be requested 6 months before expiry of the current card at the earliest.

In case of damage, theft or loss of the card, the company must submit the following documents for a new application:

- in case of loss, a written declaration relating to the loss

- in case of theft, proof of the police report
- in case of damage or malfunction, the card which is to be replaced

When first inserting the company card, the company logs itself in on the DTCO 4.1x so that it is run as the tachograph of this company until logout or insertion of a different company card. This ensures the access rights to the data assigned to the company.

The company card offers the following options within its authorisation level:

- Logging in and out the company when using this DTCO 4.1x, for example when selling the vehicle, expiry of the vehicle lease
- Entering the member state and the vehicle's registration number
➔ *Inserting member state and vehicle registration number* [74].
- Access to the mass memory data and the data assigned to the company, e.g. events, disruptions, speed, driver's name

- Access to data from an inserted driver card
- Access to the front interface for authorised download of the mass memory data

In the EU, the data must be downloaded every 3 months from the mass memory.

In the following cases, it is also useful to download the data:

- Sale of the vehicle
- Immobilisation of the vehicle,
- When replacing the DTCO 4.1x

■ Menu functions in the company mode

The navigation within the menu functions always follows the same system.

➔ *Navigating within menus* [▶ 46].

If the company card is inserted into drawer 2, all main menus which are assigned to this card drawer remain locked.

➔ *Menu access lock* [▶ 90].

In this case, you can only display, print out or download data from a driver card inserted in card drawer 1.

➔ *First menu level – Standard values* [▶ 79].

■ Registration – inserting company card

IMPORTANT

Operation by contractor equals the operating mode “Company” as per Implementation Regulation (EU) 2016/799 Annex I C, as amended.

- Insert the company card into a free card drawer;
 - ➔ *Inserting card* [▶ 47].
 By inserting the company card, the language stored on the card is set on the display.

IMPORTANT

You can set your preferred language individually.

➔ *Setting the language* [▶ 81]

The menu displayed guides you step by step to the complete operational readiness of the DTCO 4.1x:



Fig. 41: Welcome display

For approx. 3 seconds, the name of the cardholder, the set local time 16:00 and the UTC time 14:00UTC are displayed (time difference = 2 hours in summer time).

IMPORTANT

No entries are possible while the card is being read.

If a button is pressed, a message is displayed.

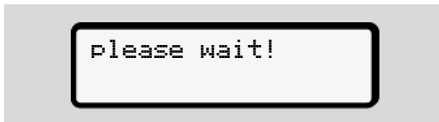

Fig. 42: Message - option I

Or

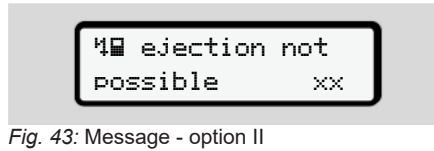

Fig. 43: Message - option II

The card information is being read:



Fig. 44: Reading the card information

The left side displays the number of the card drawer into which the card is inserted.

Next to it is the company's designation (read from the company card).

A progress bar shows the continued reading of the company card.

- Insert – if prompted – the country symbol and the vehicle registration of the vehicle:
→ *Inserting member state and vehicle registration number [p. 74]*

- If not yet carried out on this DTCO 4.1x, the company is now logged in:

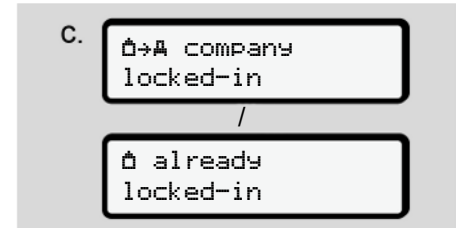

Fig. 45: Logging in the company

The login has now activated the company lock until revocation.

This ensures that company-specific and also personal data of the driver assigned to this company are protected against access.

The standard display follows.

The DTCO 4.1x is in operating mode **Company**, symbol \hat{A} :

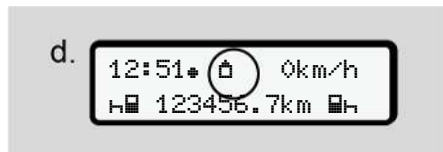

Fig. 46: Standard display with inserted company card

Result: The DTCO 4.1x is ready.

- You can only download mass memory data in order to archive and evaluate these according to legal requirements.
→ *Downloading data* [▶ 50]
- You can also access the data of an inserted driver card, e.g. to download it.
- Faults on the DTCO 4.1x or the system components are shown in the display. Confirm the message with the button **OK**.
→ *Meaning of messages* [▶ 109]

■ Inserting member state and vehicle registration number

Country identification and registration number are stored as standard during the installation and calibration by the authorised specialist workshop.

- If this was not the case, you will be prompted by the DTCO 4.1x during first insertion of the company to enter the following vehicle data:
 - Member state
 - Vehicle registration number.
→ *Inserting member state and vehicle registration number* [▶ 74]

The entries are stored in the DTCO 4.1x.

IMPORTANT

Correctly entering the registration number.

You can only enter the registration number into the DTCO 4.1x once.

Therefore, please enter the registration number exactly as it appears on the vehicle.

After that, a change is only possible through an authorised specialist workshop using a workshop card.

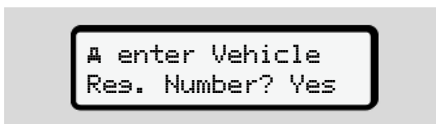

Fig. 47: Prompt for entering the registration number

1. Use the buttons **▲/▼** to select **Yes** and confirm with button **OK**.
The request to enter the member state is displayed:



Fig. 48: Selection option Country

2. Select the country symbol of the member state using the buttons **▲/▼** and confirm using the button **OK**.

A pre-selection is available based on the issuing member state of the company card.

The following display prompts the entry of the registration number. The first position to be entered is flashing _.



Fig. 49: Entry of the registration number

3. Select the required characters using the buttons **▲/▼** and confirm using the button **OK**.

IMPORTANT

Using the button **⏪** you can navigate back step by step and amend entries.

- The next position to be entered is flashing _.
4. Repeat step 3 until you have entered the complete registration number. A maximum of 13 characters are allowed.
 5. Confirm the entered registration number again using the button **OK**. Upon confirmation, a control printout is automatically created:



Fig. 50: Control printout

- The display shows the registration number again – with the option to correct it:

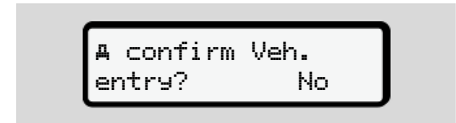

Fig. 51: Selection to confirm

6. Check if the registration number on the printout is correct.
7. Using buttons **▲/▼**:
 - to select **No** if the vehicle registration number is incorrect and confirm using button **OK**.

The display to step 1 is shown again and you can repeat your entries.

- **Yes** if the vehicle registration number is correct and confirm using button **OK**.

Country identification and registration number of the vehicle are stored in the DTCO 4.1x.

6

If a change is required, e.g. due to a change of location, contact an authorised specialist workshop holding a workshop card.

■ Removing company card

IMPORTANT

To protect the data of your company and to prevent any misuse of the card itself, you should not leave it inside the vehicle.

You can only remove the company card from the card drawer when the vehicle is stationary.

IMPORTANT

For operating the ADR variant, the ignition must be switched on.

Please observe the special safety notes for the operation of the ADR variant of the DTCO 4.1x in explosive environments.

→ *ADR version (Ex version)* [▶ 25]



Fig. 52: Request company card (combination button)

- Keep the combination button for card drawer 1 or card drawer 2 pressed down for at least 2 seconds.



Fig. 53: Transferring the user data

- The company's name is displayed.
- A status bar shows the writing process of the company card.
- The logoff request is displayed.

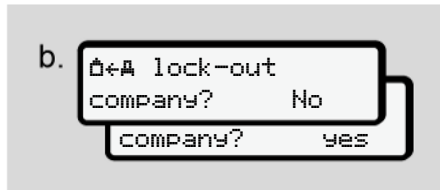

Fig. 54: Logging off the company on the DTCO 4.1x

1. Use the buttons to select:
 - No, the company is not logged off and the company lock remains activated.
 - Yes, the company is logged off and the company lock is deactivated.

Confirm using the button.

IMPORTANT

Despite the deactivated company lock, your company data stored up to that point will remain locked for a third company. However, newly recorded data is no longer locked.

IMPORTANT

A note is displayed in case a periodic verification of the DTCO 4.1x is due or the company card is expiring.

2. Remove your company card from the card drawer.
→ *Removing company card* [76]
The display shows:

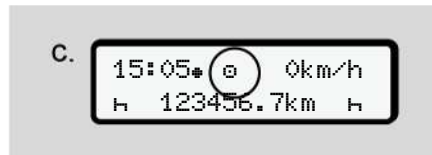

Fig. 55: Standard display without cards

The DTCO 4.1x is in "**operational**" mode again, symbol .

Menus

First menu level – Standard values

Second menu level – menu functions

Menus

■ First menu level – Standard values

► Display in stationary vehicle

This chapter describes the menus of the DTCO 4.1x which can be selected in a stationary vehicle.

Displays during journey → *Displays during journey* [► 44]

Starting point is the standard display (a), which is shown after “ignition on” in the display (default).

IMPORTANT

When activated, the option VDO Counter can also be displayed as the standard display.

IMPORTANT

Menu functions for the display and the printout of driver data are only available if a corresponding card is inserted.

This way, e.g. The menu point printout  driver 2 is only displayed if a driver card is inserted into Kartenschacht-2.

IMPORTANT

The option VDO counter (*) is displayed as an example in the following graph. Description of the VDO Counter → *VDO Counter (option)* [► 81]

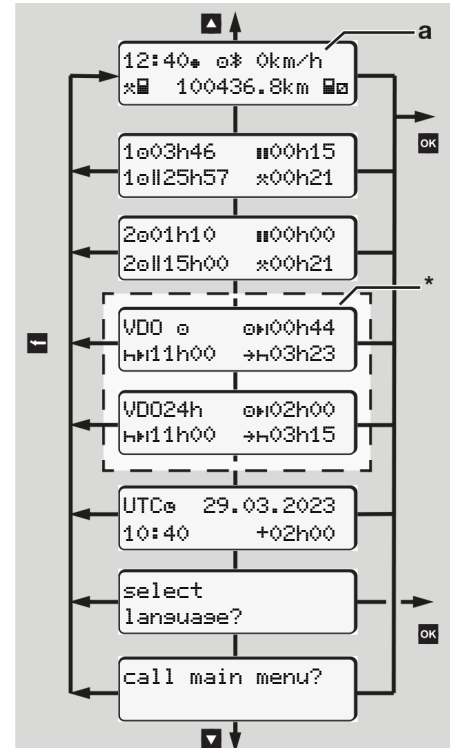

Fig. 56: First menu level (*=Option VDO Counter)

7

Based on the standard display **(a)** as well as the corresponding inserted card, you can use the **▼** **▢** buttons to request the following information:

- Standard display **(a)** (e.g. after “ignition on”)
- Two menus with information about the times of the inserted driver cards (1 = driver 1, 2 = driver 2)
→ *Display the times of the driver card* [▶ 80]
- (VDO) = Daily/weekly planning using the VDO counter (option)
→ *VDO Counter (option)* [▶ 81]
- (UTC) = The UTC time with date as well as the set time difference (offset) for the local time
→ *Set Local time* [▶ 100]
- The menu to set the desired language
→ *Setting the language* [▶ 81]

Use the key **⏪** to return directly to the standard display **(a)**.

By pressing the **OK** button, you will go to the second level – to the menu functions.
→ *Second menu level – menu functions* [▶ 87]

► **Display the times of the driver card**

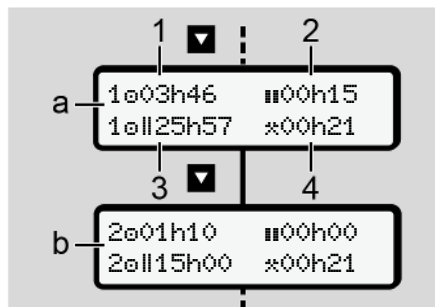

Fig. 57: Data from driver card 1 or 2.

(a)	Times of driver 1
(b)	Times of driver 2
(1)	Driving time of driver 1 since a valid rest time
(2)	Valid rest time "00" in break periods of at least 15 minutes and next 30 minutes, in accordance with regulation (EC) 561/2006
(3)	Sum of driving times over two weeks
(4)	Duration of the set activity

IMPORTANT

If no driver card is inserted, the times – except (3)– are displayed which correspond to the last status of card drawer 1 or 2, respectively.

► Setting the language

As standard, each driver card has the language of the request assigned for the displayed information (issuing authority).

You can adjust this default setting on each DTCO 4.1x by setting a different language.

The DTCO 4.1x remembers the set language by means of the card number of the inserted card.

Up to 5 languages can be stored.

1. Use the **▲** / **▼** buttons to select the `select language?` function and press the **OK** button.
2. Use the buttons **▲** / **▼** to select the desired language and confirm your selection with the button **OK**.

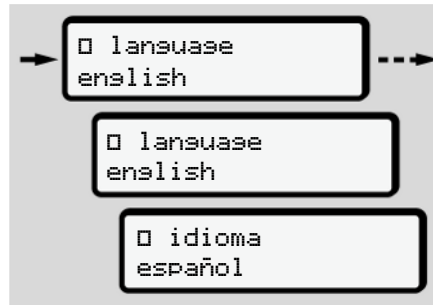

Fig. 58: Select the desired language

3. The DTCO 4.1x shows the successful storage of the language in the newly selected language.

► VDO Counter (option)

IMPORTANT

The VDO Counter can be activated optionally.

If necessary, contact your authorised specialist workshop.

The VDO Counter (option) supports your daily-/weekly planning by displaying the remaining driving and rest times.

IMPORTANT

Observe legal regulations.

Owing to possible different interpretations of Regulation (EC) 561/2006 and the AETR Regulations by the national

7

supervisory authorities and additional system restrictions, the following will continue to apply unreservedly:

The VDO counter does not release the user from the duty to record and independently evaluate driving, rest, standby and other working times in order to observe applicable provisions.

With other words: The VDO counter does not claim to be a generally valid, error-free display of the legal provisions.

Further information on the VDO Counter is available on the Internet at www.fleet.vdo.com

IMPORTANT

In order for the VDO counter to display valid information, the following conditions must be met for the evaluation of the data:

- Complete addition of your activities to the driver card.
→ *Manual entries (entry/addition)* [▶ 63]
- Correct setting of the current activity – no remote control; e.g. no unintentional setting of the activity working time \times instead of daily rest time h .
→ *Setting activities* [▶ 59]
- Entry of ferry/train and your current activity.
→ *Ferry/ train: Enter start/ end* [▶ 99]

Description of the VDO Counter display

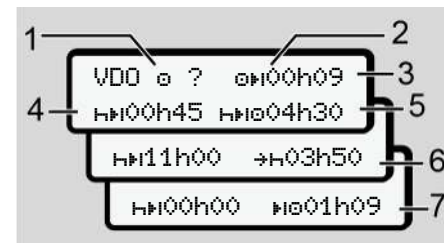

Fig. 59: VDO Counter – layout of the display

IMPORTANT

The flashing h means: This display part is currently active.

- (1) **Currently set activity**
- (2) **? = User information**

Periods with unknown activity ? or insufficient data are recorded on the driver card (e.g. use of a new driver card).

The VDO counter evaluates missing activities, such as the activity h . If a relevant time overlap is determ-

ined in the driver activities, then this will be shown in the display by the ! \odot symbol instead of the ? symbol and the driver activity.

(3) Remaining driving time \odot H

When driving: Displays how long driving may continued.

(\odot H $\overline{00}h00$ = driving time completed)

(4) Remaining rest time H \overline{H}

Length of the next required break/rest time.

While the activity H is set, the remaining break time will be counted down.(H \overline{H} $\overline{00}h00$ = break finished).

(5) Future driving time H \overline{H} \odot

Duration of the future driving time after having observed the break time / rest time.

(6) Latest start daily rest time $\overline{+}$ H

If, for example, the set activity $\overline{+}$, the remaining time to the start of your required daily rest time, is displayed.

(7) Start of the next driving time \overline{H} \odot

The next driving time may only start after this time has lapsed.

VDO Counter – displays while driving

IMPORTANT

Please observe the working time specific country rules.

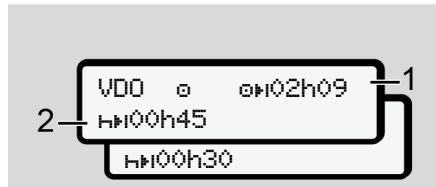

Fig. 60: Activity \odot – remaining driving time vs. daily rest time

(1) Remaining driving time

(2) At the latest after the end of the driving time displayed (1) a break or continuation of the cumulated break must occur.

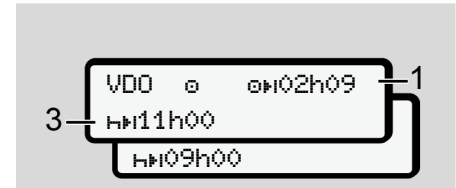

Fig. 61: Activity \odot – remaining driving time vs. daily rest time

(3) At the latest after the end of the driving time displayed (1), a mandatory rest time must follow.

If allowed, the rest time can be taken in two parts, whereby the second part must cover an uninterrupted period of 9 hours.

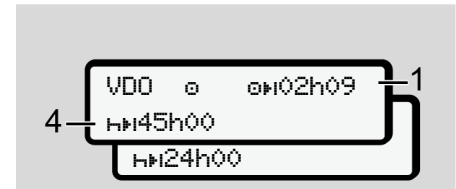

Fig. 62: Activity \odot – remaining driving time vs. weekly rest time

7

- (4) At the latest after the end of the driving time displayed (1), a periodic weekly rest time must follow. If permitted, the upcoming weekly rest time can be shortened.

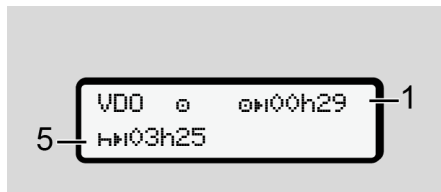

Fig. 63: Activity 0 – ferry/train vs. rest time continuation

- (5) The VDO counter detects the location on a ferry/train.

Requirement: Correct entry of this function:

→ *Ferry/ train: Enter start/ end* [p 99].

At the latest after the end of the driving time (1), the daily rest time must be continued.



Fig. 64: Activity 0 – out of scope

- (6) The display of the remaining driving time is active (h flashes), a countdown takes place.

The VDO counter evaluates activity 0 as activity *

IMPORTANT

Please note that the calculations of the driving and rest times for the VDO counter occur according to Regulation (EC) 561/2006 and not according to Implementation Regulation (EU) 2016/799 Annex I C, as amended.

Therefore, there may be deviations from the standard displays of the DTCO 4.1x.

VDO Counter – displays for rest time activity

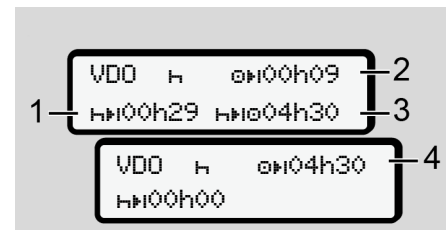

Fig. 65: Activity H – rest time vs. available driving test

- (1) Remaining rest time
- (2) Remaining driving time, if the rest time (1) is not observed.
- (3) Period of the next available driving time after the end of the rest time displayed (1).
- (4) Available driving time after a valid rest time.

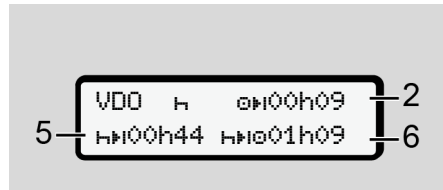

Fig. 66: Activity H – rest time vs. available daily driving time

- (5) Remaining rest time.
- (6) Length of the available daily driving time after the end of the rest time (5).

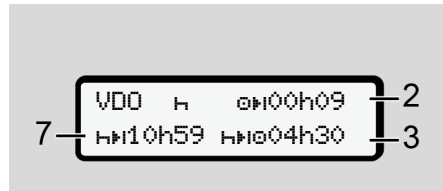

Fig. 67: Activity H – daily rest time

- (7) Remaining daily rest period.
If permitted, split into 3 + 9 hours.

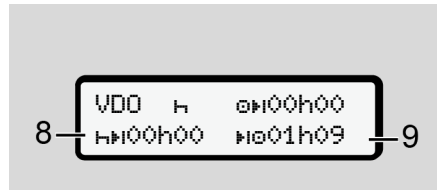

Fig. 68: Activity H – End of rest time

- (8) Valid rest time complete.

The display **00h00** flashes for 10 seconds. If the rest time is continued, the VDO Counter changes to the period of the next daily or weekly rest time.

- (9) Beginning of the next driving time.

Situation: The maximum weekly driving time or double weekly driving time has already been reached.

Although the valid interruption was observed, the VDO Counter recognises that a new driving period is only possible after the end of the displayed time.

VDO Counter – Displays for activity working time

IMPORTANT

Please observe the working time specific country rules.

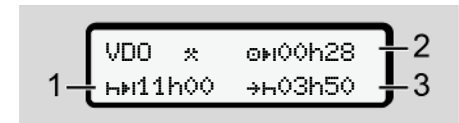

Fig. 69: Activity * – work time vs rest time

- (1) Duration of the next daily rest time.
- (2) Still remaining driving time.
- (3) Start of the next daily rest time. At the latest before the displayed time comes to an end, a daily rest time must be kept.

7

Note:

Activity \square is evaluated by the VDO Counter during an interruption of the driving time comparable to activity \square (outside of the daily rest time).

Use keys \blacksquare / \blacktriangleright to retrieve further information.

VDO Counter – displaying daily values

Fig. 70: Activity \square – daily value

- (1) Symbol for the display of the daily values
- (2) Remaining daily driving time
- (3) Duration of the next daily rest time
- (4) At the latest before the displayed time comes to an end, a daily rest time must be kept.

VDO Counter – displaying weekly values

Fig. 71: Activity \square – Weekly values

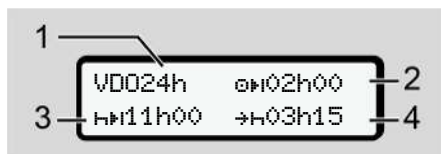
- (1) Symbol for the display of the weekly values since the last weekly rest time
- (2) Remaining weekly driving time
- (3) Length of the weekly rest time. At the latest after six daily driving times, a weekly rest time must follow.
- (4) The weekly rest period must start before the displayed time comes to an end at the latest.

IMPORTANT

The displays in relation to weekly rest time (3) and (4) may be deactivated for the transnational passenger transport.

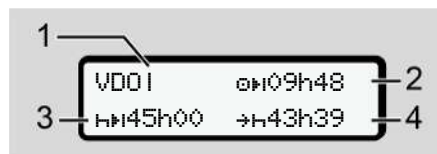
If the calculation of the weekly values was deactivated in the VDO counter, these values are not displayed.

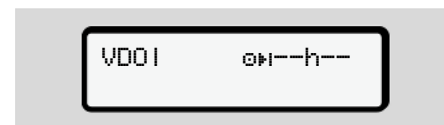

Fig. 72: Display deactivated calculation

VDO Counter – status display

Fig. 73: VDO Counter – status display

- (1) Symbol for the status display
- (2) Symbol for crew operation
Is displayed if crew operation is used since the start of work. The VDO Counter observes the rules applicable in these calculations.
- (3) In this week, two more reduced daily rest times are permitted (max. 3x per week possible).

- (4) In this week, one more extended daily driving time of a maximum of 10 hours is permitted (max. 2x per week possible).
- (5) Reconciliation of a shortened weekly rest time
- Due to a shortened weekly rest time, the time displayed must be reconciled, with a rest time of at least 9 hours.

IMPORTANT

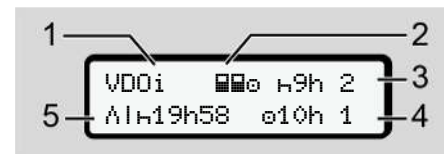
The display for a shortened weekly rest time (5) may be deactivated for the transnational passenger transport.

If the evaluation of the weekly values in the VDO Counter is deactivated, the values are not displayed.

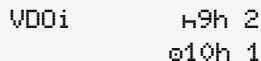

VDOi 49h 2
 010h 1

Fig. 74: Display deactivated calculation

■ Second menu level – menu functions

You can access the second menu level by pressing **OK** on the first menu level or selecting the menu point retrieving menu functions.

→ *First menu level – Standard values*
[79]

IMPORTANT

If you have selected a menu point but do not carry out an entry within 30 seconds, the DTCO 4.1x returns to the first menu level.

All inputs not confirmed up to that time are rejected.

IMPORTANT

The menu functions may be called up only if the vehicle is stationary.

If you and your vehicle are not in an explosive environment, the ignition must be switched on to operate the ADR version.

► Menu structure (overview)

- ```

> printout OK driver 1 4)
 |-- 24h OK day
 |-- !x OK event
 |-- OK activities
 ▼
> printout OK driver 2 5)
 |-- 24h OK day
 |-- !x OK event
 |-- OK activities
 ▼
> printout OK vehicle
 |-- 24h OK day
 |-- !x OK event
 |-- >> OK overspeed
 |-- OK techn. data
 |-- OK cards
 |-- OK v-diasram
 |-- OK status D1/D2 1)
 |-- %v OK v-profiles 1)
 |-- %n OK n-profiles 1)

```

|                              |                                 |                                                    |
|------------------------------|---------------------------------|----------------------------------------------------|
| ▼                            | -- \$ licence code              | -- A weight                                        |
| >entry > driver 1            | -- centr. language 1)           | -- DTDC version                                    |
| -- * basin country           | -- * in-vehicle pairing 2)      | ▼                                                  |
| -- * end country             | -- * Bluetooth manage 3)        | > display control 6)                               |
| -- ? settings                | devices                         | -- Serial number of 6)                             |
| -- * Bluetooth               | -- * Bluetooth configuration 3) | sensor                                             |
| -- miscellaneous             | ▼                               | ▼                                                  |
| ▼                            | > display driver 1 4)           | > menu # Toll 7)                                   |
| >entry > driver 2            | -- 24h day                      | 1) Option                                          |
| -- * basin country           | -- !x event                     | 2) Setup with only the company card                |
| -- * end country             | ▼                               | 3) Menu functions with the company card inserted   |
| -- ? settings                | > display driver 2 5)           | 4) Only with driver card inserted in card drawer 1 |
| -- * Bluetooth               | -- 24h day                      | 5) Only with driver card inserted in card drawer 2 |
| -- miscellaneous             | -- !x event                     | 6) Only with inserted control card                 |
| ▼                            | ▼                               | 7) Only with the VDO Link inserted                 |
| >entry > vehicle             | > display vehicle               |                                                    |
| -- OUT+ basin/+OUT end       | -- 24h day                      |                                                    |
| -- + basin/+ end Ferry/train | -- !x event                     |                                                    |
| -- * load/unload             | -- >> overspeed                 |                                                    |
| -- * local time              | -- Techn. data                  |                                                    |
| -- * company time            | -- cards                        |                                                    |
|                              | -- company                      |                                                    |



► Navigating within menu functions

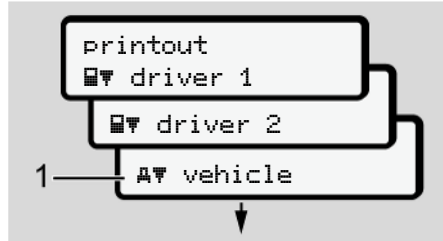

Fig. 75: Scrolling in (main) menu

1. Use the buttons **▲** / **▼** to navigate to the required main menu (grey fields of previous list, e.g. to the printout of the vehicle data (1). Flashing in the 2. row (1) (in italics) indicates that there are further selection options.

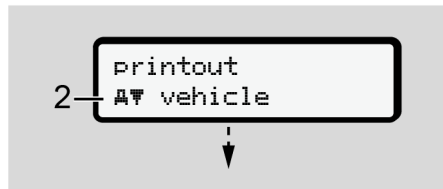

Fig. 76: Selection of a menu item

2. Press the **OK** button if you want to get to the required function (2) with possible further selection options.



Fig. 77: Selection of a menu function

The selected menu point (3) is displayed, the further selectable functions are flashing in the 2nd row (4).

The display of the display and print menus is based on the inserted driver cards in driver drawer 1 and 2:

- If a driver card is inserted in card drawer-1, printout **printout driver 1** is displayed.
- If a driver card is inserted in card drawer-2, printout **printout driver 2** is displayed.

- If no driver cards are inserted, only printout **vehicle** is displayed.

This does not apply to the input menus.

3. Use the **▲** / **▼** buttons to select the required menu point, e.g. the printout of the daily value (4) and confirm your selection with the **OK** button.

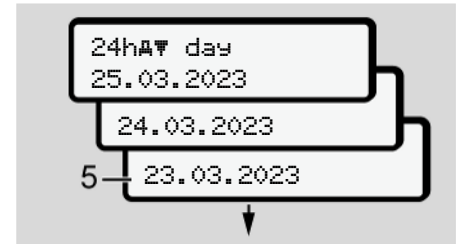

Fig. 78: Select the desired day

4. Use the **▲** / **▼** buttons to select the required day and confirm that selection with the **OK** button.

7

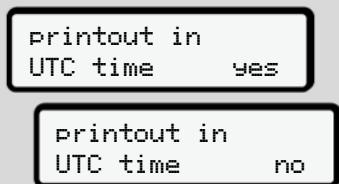

Fig. 79: No = printout in local time

5. Use the **▲** / **▼** buttons to select the required printout type and confirm the selection with the **▶** button. For 3 seconds, the DTCO 4.1x indicates that a printout has started. You can cancel the printout.  
 → *Cancel print* [▶ 127]

Next, the last selected menu item is displayed.

6. Further action:
- Select another printout with the **▲** / **▼** buttons.
  - Use the **▶** button to return to the next higher menu level.

### ▶ Menu access lock

According to the regulations, access to stored data is regulated via access rights and implemented by means of corresponding tachograph cards.

Display example of a missing authorisation:

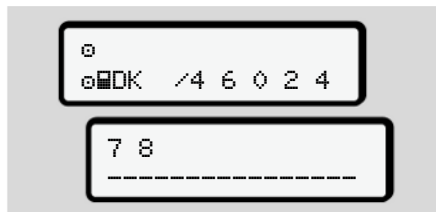

Fig. 80: Missing authorisation

The display of the expected data is incomplete. Personal data is partially or completely masked.

### ▶ Leaving menu functions

#### Automatically

The menu is exited automatically in the following situations:

- after a tachograph card is inserted or requested.
- After 1 minute of inactivity.
- With start of journey.

**Manually**

1. Press the **ESC** button.
  - The started selection or entry is terminated.
  - The next higher selection level is displayed again.
  - The subsequent request is displayed:

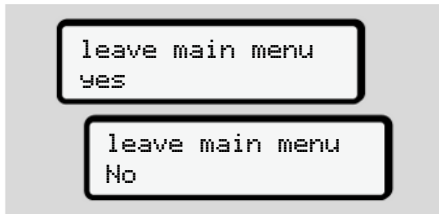

Fig. 81: Leaving menu function

2. Use the **▲** / **▼** buttons to select Yes and confirm with the **OK** button. Or use the **ESC** button to skip the query. The display shows the standard display **(a)** again.

**► Menu point printout driver 1/ driver 2**

Using this menu point, you can print out the data of an inserted driver card.

**Note:**

- The procedure is identical for both driver cards.
- You can select the desired printing type prior to every printout.

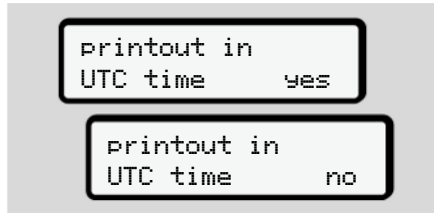

Fig. 82: No = Printout in local time

**Print daily value**

**IMPORTANT**

If possible, create the printout in the morning for the previous day. This way, you ensure that the last registered activity of the previous day is included.

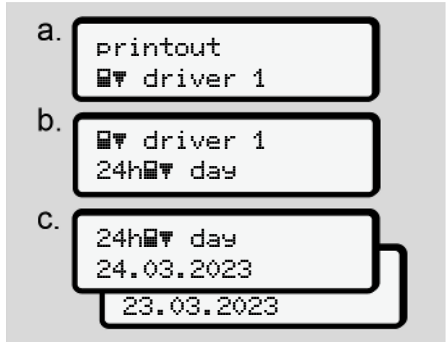

Fig. 83: Menu sequence printout – daily value for driver 1

Based on the selection, all activities of the selected day are printed.

→ *Printouts (examples)* [p. 130]

**Print events**

Fig. 84: Menu sequence printout – events

Based on the selection, the saved events and malfunctions or those still active are printed.

→ *Technical data* [▶ 135]

**Printing activities**

Fig. 85: Menu sequence Printout – activities

From the selected day onwards, a printout of all activities of the last 7 calendar days follows.

→ *Driver activities* [▶ 136]

**► Menu point printout vehicle**

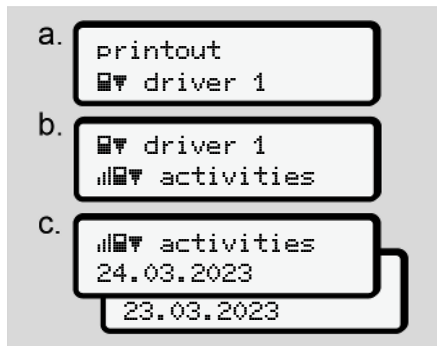
Use can use this menu point to print out the vehicle data from the mass memory.

Select the required function (described below).

Next, the required time is prompted.

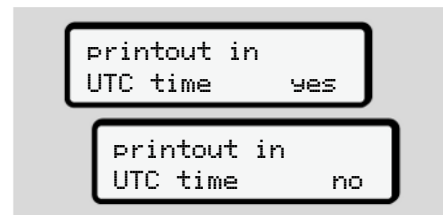

Fig. 86: No = Printout in local time

**Print daily value**

**IMPORTANT**

If possible, create the printout in the morning for the previous day. This way, you ensure that the last registered activity of the previous day is included.

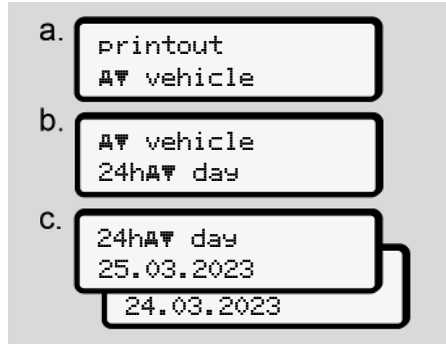

Fig. 87: Menu sequence printout – daily value for driver-1 and driver-2

Based on the selection, all driver activities are printed, separated chronologically by driver 1/ driver 2.

→ *Daily printout of the vehicle* [▶ 132]

**Printing out events [vehicle]**

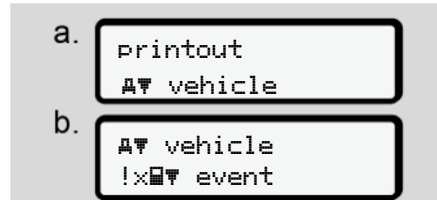

Fig. 88: Menu sequence printout – events vehicle

Based on the selection, the saved events and malfunctions or those still active are printed.

→ *Events / faults from the vehicle* [▶ 134]

**Print instances of speeding**

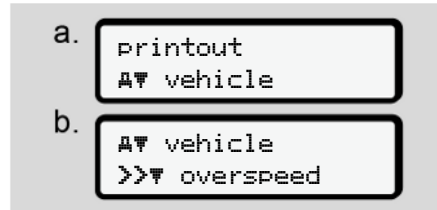

Fig. 89: Menu sequence printout – speeding

Based on the selection, excess speeds of the speed value set on the DTCO 4.1x are printed.

→ *Speeding events* [▶ 135]

**Print technical data**

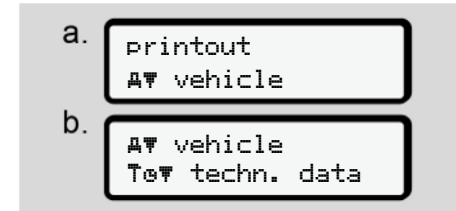

Fig. 90: Menu sequence printout – technical data

Based on the selection, data regarding vehicle registration, sensor identification and calibration are printed.

→ *Technical data* [▶ 135]

7

### Printing information on inserted tachograph cards

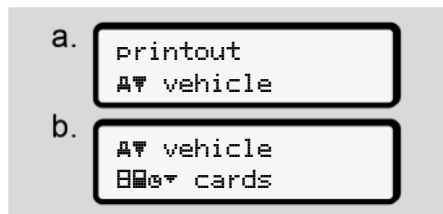

Fig. 91: Menu sequence printout – info tachograph cards

The data of all inserted tachograph cards is printed.

➔ *Inserted tachograph cards* [▶ 137]

### Printing v-diagram

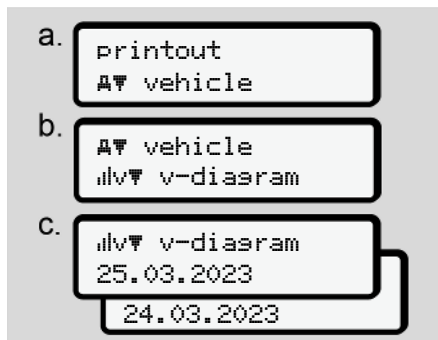

Fig. 92: Menu sequence printout – v diagram

From the selected day on, there is a printout of course of speed.

➔ *v-diagram* [▶ 136]

### Printing status D1/ D2 (option)

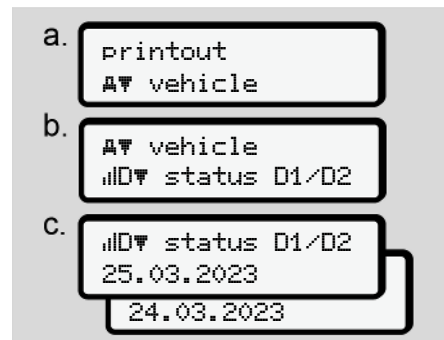

Fig. 93: Menu sequence printout – status D1/ D2

From the selected day onwards, a printout of the status inputs of the last 7 calendar days.

➔ *Status D1/D2 diagram (option)* [▶ 136]

### Printing speed profiles (option)

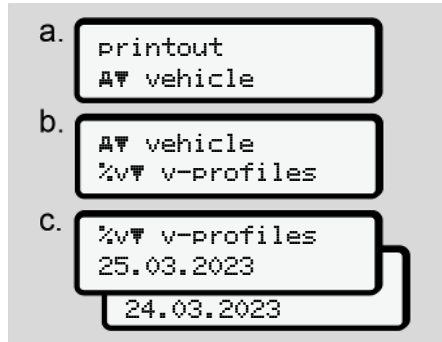

Fig. 94: Menu sequence printout – speed profile

Based on the selection, a profile printout of the speeds driven is performed.

→ *Speed profiles (option)* [▶ 137]

### Printing speed profiles (option)

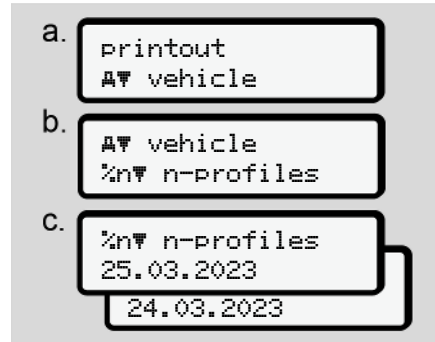

Fig. 95: Menu sequence printout – rpm profile

Based on the selection, a profile printout of the motor speed is performed.

→ *Rotation frequency profiles (option)* [▶ 137]

### ▶ Menu point Entry driver 1/driver 2

#### Enter country

In addition to entering the country when inserting or removing the driver card, this can be done in this menu point.

#### IMPORTANT

According to the Regulation, both driver 1 and driver 2 must enter the country in which the shift starts or ends, into the tachograph.

#### Note:

- The procedure is identical for both drivers.

7

**Start country**

Select the listed functions step by step.

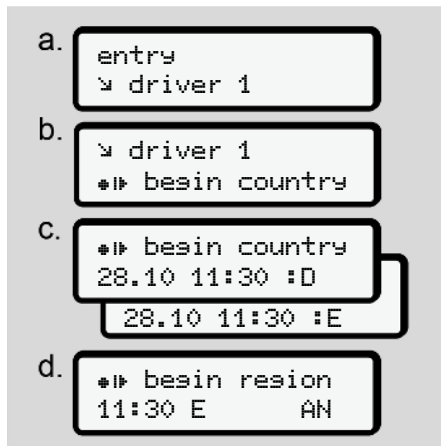

Fig. 96: Menu sequence entry – start country

**IMPORTANT**

Based on your location, DTCO 4.1x offers a list of countries from which you can choose when selecting a country.

In this pre-selection – with the exception of individual countries – no countries are listed that do not belong to the EU.

If you have “selected *Spain*” as the country, you will automatically be prompted to enter the region (**step d**).

**End country**

Fig. 97: Menu sequence entry – end country

If you have selected *Spain* as the country, you will automatically be prompted to enter the region (**step d**).

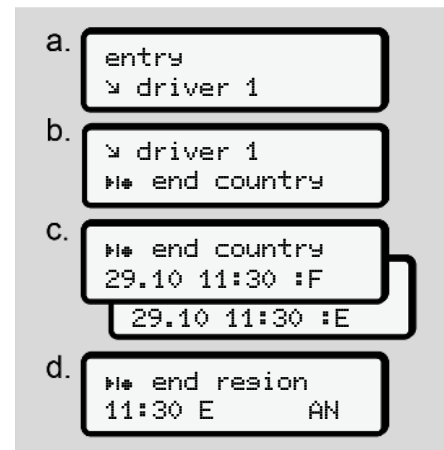

## Settings

### Changing settings to personal ITS data

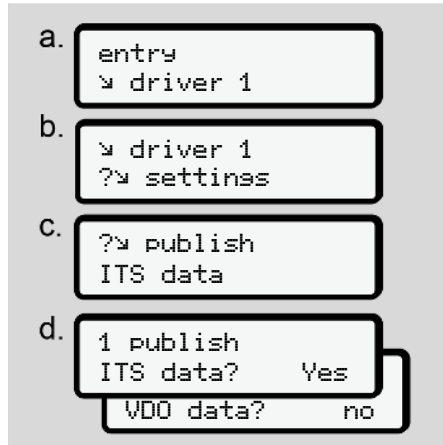

Fig. 98: Menu sequence entry – personal data

→ Inserting driver card for the first time [▶ 68].

### Changing settings to personal VDO data

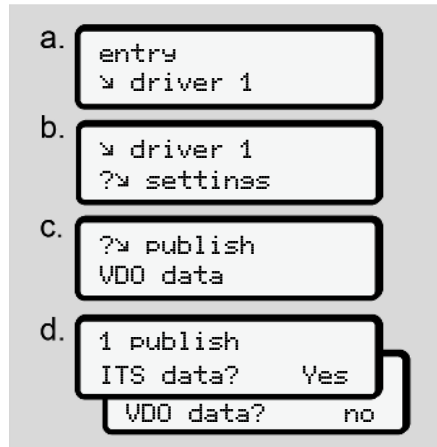

Fig. 99: Menu sequence entry – personal special data

→ Inserting driver card for the first time [▶ 68].

### My company

In this menu, you can enter the country in which your company is based.

## Bluetooth pairing

This menu allows you to pair external devices via Bluetooth using the DTCO 4.1x.

1. Switch on Bluetooth on your external device.
2. On the DTCO 4.1x, go to the driver menu "⌘ Bluetooth"

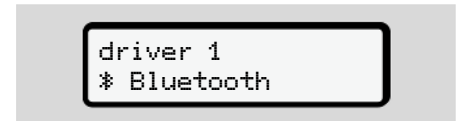

Fig. 100: Driver1 - Bluetooth

3. Press the **OK** button.
- ⇒ The display shows:



Fig. 101: Bluetooth pairing

4. Press the **OK** button.
- ⇒ The display shows:

7



\* pairing  
please connect

Fig. 102: Request connect Bluetooth

5. Your external device now displays the DTCO 4.1x in the Bluetooth menu.
6. Pair the DTCO 4.1x on your external device (depending on the respective external device).
7. A 6-digit PIN appears on your external device and on the DTCO 4.1x. The two PINs must match.

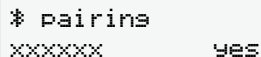

\* pairing  
xxxxxxx      yes

Fig. 103: Confirm pairing

8. Confirm “pairing” on your external device (depending on the respective external device).
9. Confirm the pairing on the DTCO 4.1x by pressing the  button.

10. Complete the pairing by pressing the  button.

11. Pairing has been successfully completed.



entry stored

Fig. 104: Save confirmation

12. “\*” is now displayed in the top row of the standard display → *Displays* [▶ 44].

### IMPORTANT

When removing the driver card, Bluetooth automatically becomes inactive.

When re-inserting the driver card, Bluetooth automatically becomes active again.

### IMPORTANT

When using the remote control, the user is responsible for the legal completeness and correctness and recognises this by using the remote control.

The use of the remote control is not part of the legal tachograph system. It is used on the operator's own responsibility.

The periods during which a remote control was used, can be printed and displayed.

→ *Daily printout of the vehicle* [▶ 132]

### Miscellaneous

In this display, you can make user-specific entries.

### ► Menu point entry vehicle

#### Enter OUT start / end

If you are driving the vehicle outside of the scope of the regulation, you can set the function **out of scope** in the following menu and terminate if required.

The following journeys can be outside of the scope:

- Journeys on non-public roads.
- Journeys outside of AETR states.
- Journeys for which the total weight of the vehicle does not require use of the DTCO 4.1x in accordance with the regulations.

Select the listed functions step by step.

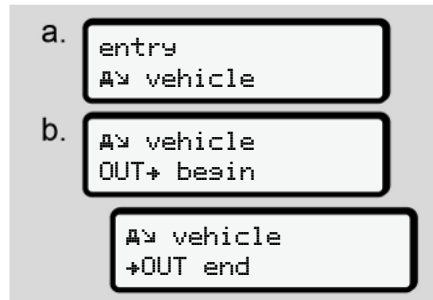

Fig. 105: Menu sequence entry – out start/end

#### IMPORTANT

The setting **out of scope** is automatically ended when you remove or insert a driver card.

### Ferry/ train: Enter start/ end

Enter the location of the vehicle on a ferry or a train as soon as you have taken your position during shipping.

Do this also for short transports to avoid the Motion conflict message.

1. Select the following menu items:

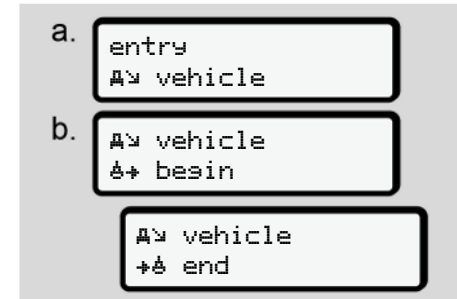

Fig. 106: Menu sequence entry – ferry / train

2. Set the start or the end of the stay on the ferry / train in the menu.

7

Recording of ferry / train is ended when:

- This is deactivated in the menu.
- The driver card is removed.
- The vehicle has been driving for longer than a minute.

Therefore, when parking the vehicle on the ferry / train, check if **Ferry/train** is active and the relevant pictogram is visible in the DTCO display.

### IMPORTANT

If the card is removed and inserted again on the ferry / train, entry **Ferry/train** must be reset.

### Towing/ transporting the vehicle

If the DTCO 4.1x is activated and the vehicle is being towed or transported, please select **Ferry/train**, to avoid the **Motion conflict** message (→ *Ferry/train: Enter start/end* [▶ 99]).

### Load/unload

In this menu, the DTCO 4.1x stores time and location of loading and unloading process.

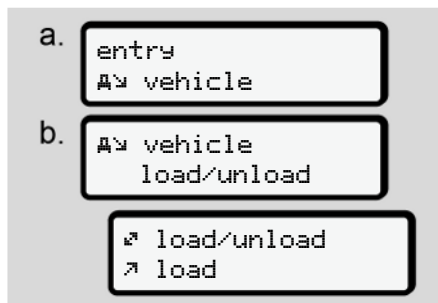

Fig. 107: Menu sequence load/unload

You can select the load process with the **▲** / **▼** buttons:

- **▲** load
- **▼** unload
- **▲** unload+load

Complete the entry with the **OK** button.

### Set Local time

#### IMPORTANT

Firstly, familiarise yourself with the chapter “Time zones” before performing a change.

→ *Time zones* [▶ 33]

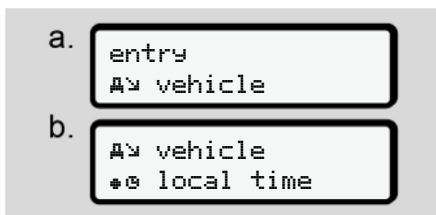

Fig. 108: Menu sequence entry – local time

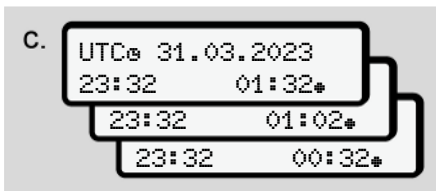

Fig. 109: Menu sequence entry – enter local time

For the standard display, you can adjust the time to the local time zone as well as to the start or end of summer time.

The latter occurs in steps of  $\pm 30$  minutes.

### IMPORTANT

Please observe the legal requirements applicable in your country.

### Setting the company local time

For ease of calculation of the working times, the DTCO 4.1x offers a working time counter which refers to the local time of the company.

This information can be requested via the front interface.

1. Select the following menu items:



Fig. 110: Menu sequence entry – local time

2. In step b you can enter date and hour of the company location and the difference from the UTC time.

### In-vehicle Bluetooth connection

Validity: Version DTCO 4.1a or higher.

This menu allows you to switch the in-vehicle Bluetooth connection on or off.

- The company card must be inserted to set up the connection.
- To connect the in-vehicle Bluetooth device, the inserted driver card must allow access to the ITS data (→ *Changing settings to personal ITS data* [ 97]).  
If this permission no longer exists, e.g. after changing the driver card, the in-vehicle Bluetooth connection remains, but data is no longer transferred.

1. Switch on Bluetooth on your external device.
2. On the DTCO 4.1a, go to the menu for connecting to Bluetooth:

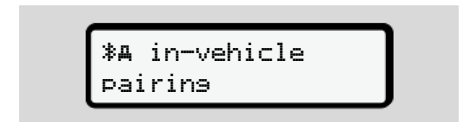

Fig. 111: In-vehicle Bluetooth: Connecting

7

3. Press the **OK** button.

⇒ The display shows:



Fig. 112: Prompt: Connect in-vehicle Bluetooth

4. Your external device now displays the DTCO 4.1a in the Bluetooth menu.

5. Pair the DTCO 4.1a on your external device (depending on the respective external device).

6. A 6-digit PIN appears on your external device and on the DTCO 4.1a. The two PINs must match.



Fig. 113: Confirm pairing

7. Confirm “connect” on your external device (depending on the respective external device).

8. Confirm the connection on the DTCO 4.1a by pressing the **OK** button.

9. Complete the pairing by pressing the **OK** button.

10. Connecting has been successfully completed.

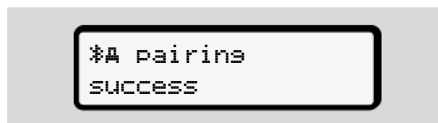

Fig. 114: Save confirmation

11. “Bluetooth” is now displayed in the top row of the standard display → *Displays [▶ 44]*.

### Unlocking additional functions

When entering a licence code you can activate additional functions on the DTCO 4.1x.

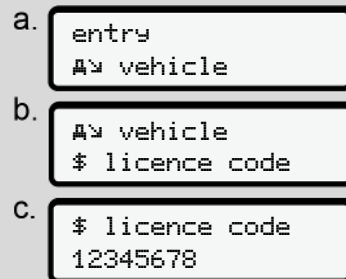

Fig. 115: Menu sequence entry – licence code

### IMPORTANT

If the licence code has already been entered, it will be displayed in full and cannot be changed.

In this case, the additional functions are already activated.

### IMPORTANT

The licence code can be purchased via the VDO online shop.

→ *VDO online shop [▶ 175]*

### Managing Bluetooth devices

- Validity: Version DTCO 4.1 a or higher.
- Only with company or workshop card.

This menu allows you to manage device connections.



Fig. 116: Menu: Managing the device

1. Press the **OK** button.
  - ⇒ The display shows the names of the coupled devices:
2. The **▲** / **▼** buttons allow you to browse through the displayed devices.
3. Confirm the desired device with **OK**.

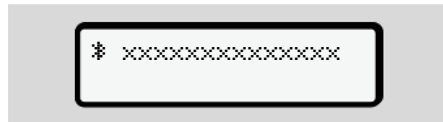

Fig. 117: Device name

4. A menu to remove the device follows:

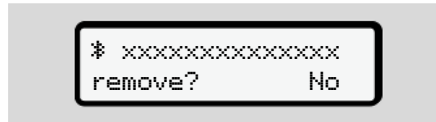

Fig. 118: Remove device?

5. Select **Yes** or **No** and confirm using the **OK** button.
  - ⇒ A menu confirming the removal appears:

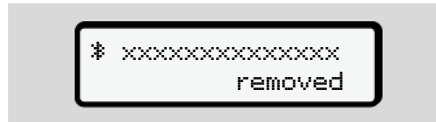

Fig. 119: Confirming the removal

### Bluetooth configuration

- Validity: Version DTCO 4.1 a or higher.
- Only with company or workshop card.

This menu allows you to set the time behaviour of the Bluetooth connection.

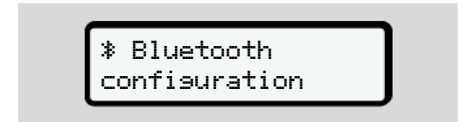

Fig. 120: Menu: Bluetooth Configuration

1. Press the **OK** button.
  - ⇒ The display shows the name of the paired device:

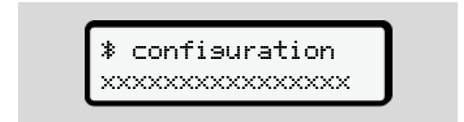

Fig. 121: Display device name

2. Press the **OK** button.
  - You can now choose the following options:

7

\* on, 24 h:

- Ignition on: ITS/Bluetooth is on
- Ignition is switched off: ITS/Bluetooth will be on for 24 h and then switched off

\* on:

- ITS/Bluetooth is on permanently, even when the ignition is off

Ign. Off, \* off:

- Ignition on: ITS/Bluetooth is on
- Ignition off: ITS/Bluetooth is off

3. Select the desired option and confirm using the  button.

⇒ A menu confirming the option appears:



entry stored

Fig. 122: Save confirmation

### ► Menu point display driver 1/ driver 2

You can use this menu point to display the data of your inserted driver card.

#### IMPORTANT

Comparable to a printout, the data is shown on the display, whereby one row of the printout (24 characters) is shown split in two rows.

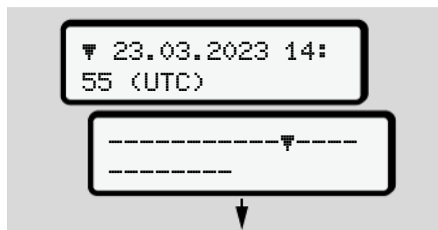



Fig. 123: Example for the data display

If, during scrolling through the information, you scroll back using buttons  /  you can only call up approx. 20 previous rows of the printout.

Use the button  to leave the display.

Note:

- Calling up the functions to display the data is identical with the ones for printing the data. Therefore, they are not described any further below.
- It is possible to call up every display in local time.

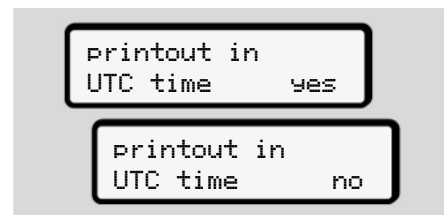

Fig. 124: No – printout in local time

- Select the possible displays for driver 1 or driver 2 step by step.



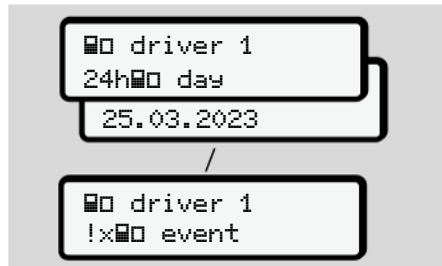

Fig. 125: Menu sequence display for driver 1

All activities of the selected days or all saved events or malfunctions or which are still active can be displayed by scrolling.

### ► Menu point display vehicle

You can use this menu point to display the data from the mass memory.

#### IMPORTANT

Comparable to a printout, the data is shown on the display, whereby one row of the printout (24 characters) is shown split in two rows.

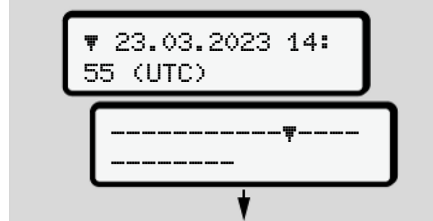

Fig. 126: Example for the data display

If, during scrolling through the information, you scroll back using buttons **▲** / **▼** you can only call up approx. 20 previous rows of the printout.

Use the button **■** to leave the display.

Note:

- Calling up the functions to display the data is identical with the ones for printing the data. Therefore, they are not described any further below.
- It is possible to call up every display in local time.

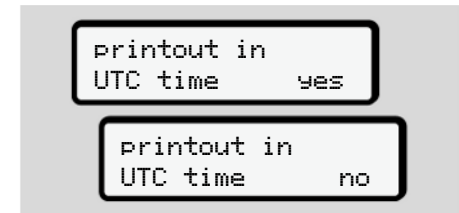

Fig. 127: No – display in local time

Select the listed functions step by step:

- displaying all driver activities in chronological order.
- displaying all saved or still active events and faults.
- displaying the instances when the set speed was exceeded.

7

- displaying data about vehicle identification, sensor identification, and calibration.
- Display data of the previously inserted tachograph card.
- display the number of the company card of the registered company. If no company is registered, \_\_\_ is displayed.
- Display current vehicle weight. (On-board weight system required)
- Display DTCO version and software version.

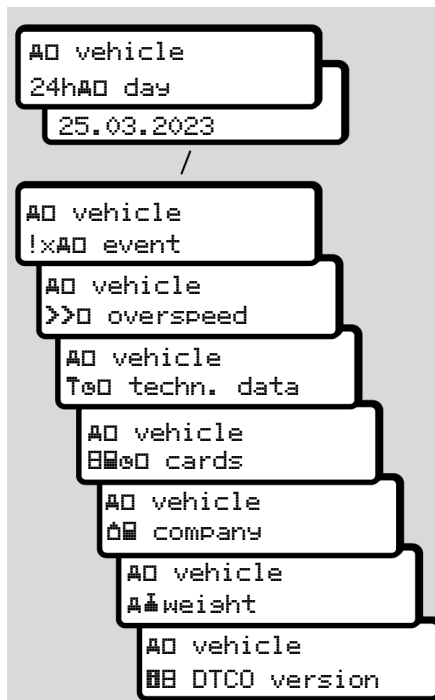

Fig. 128: Menu sequence display for vehicle

### ► Centralised language (option)

Validity: Version DTCO 4.1a or higher.

Option centralised language allows the central vehicle unit, by means of a CAN message, to set a particular display language in all devices connected to the vehicle CAN.

For the behaviour of the centralised language to be active in the DTCO 4.1a, the following requirements must be met:

- centralised language is supported in the vehicle.
- centralised language must be activated by the vehicle manufacturer.
- centralised language is then active in the DTCO 4.1a.
- A corresponding message is received via CAN 1 from the central vehicle unit.
- No control, company or workshop card is inserted.

Menu:

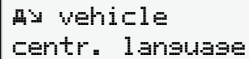

```
vehicle
centr. language
```

Fig. 129: Centralised language menu

The submenu allows you to switch the centralised language on and off.

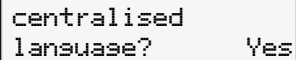

```
centralised
language? Yes
```

Fig. 130: Centralised language: Yes/No

### ► Menu point Toll (option)

If a VDO Link is inserted, the following menu is available:



```
menu
tollins
```

Menu description: See the VDO Link manual.

# **Messages**

**Meaning of messages**

**Special messages**

**Overview of possible events**

**Overview of possible malfunctions**

**Driving time warnings**

**Overview of possible operational notes**

## Messages

### ■ Meaning of messages

Errors in a component, in the device or in the operation will be displayed as a message immediately after occurring.

The following characteristics exist:

|   |                      |
|---|----------------------|
| ! | Event                |
| × | Fault                |
| ⏰ | Driving time warning |
| ℹ | Operational note     |

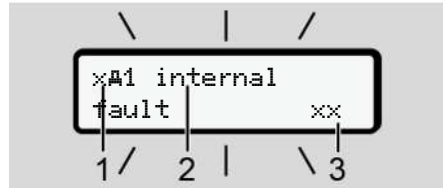

Fig. 131: Display of a message (flashing temporarily)

- (1) Pictogram combination, if necessary, with card drawer number
- (2) Plain text of the message
- (3) Error code

### ⚠ WARNING

#### Distraction due to device messages

There is a risk of distraction if messages are displayed on the device while driving or if the card is automatically ejected.

- Do not let yourself get distracted by message, but focus fully on the traffic.

### IMPORTANT

In case of messages regarding a tachograph card, the number of the corresponding card drawer is displayed next to the pictogram.

### ► Characteristics of the messages

#### Events, malfunctions

- During the displays of events or disruptions, the background lighting of the display flashes for approx. 30 seconds.  
The reason is displayed by means of a pictogram, plain text of the message and error code.
- You must confirm this message by pressing the **OK** button.
- The DTCCO 4.1x stores the event or the disruption both in the mass memory and on the driver card (according to the storage provisions of the regulation). You can display or print this data through the menu function.

### IMPORTANT



If an event keeps repeating itself, consult an authorised specialist workshop.

**IMPORTANT****Procedure in case of malfunctions**

In case of a malfunction of the tachograph, you as the driver are obliged to record the details about activities which the tachograph no longer correctly records or prints on a separate sheet or on the back of the printout.

→ *Recording activities manually* [p. 60]

**Driving time warnings**

- This message  driving time warns the driver about excessive driving times.
- This message is displayed with flashing background lighting and must be confirmed by pressing the  button.

**Operational notes**

The operating notes are displayed **without** flashing background lighting and disappear (except for individual messages) automatically after 3 or 30 seconds.



**DTCO 4.1x-enabled display instruments**

If a display instrument is installed in the vehicle which can communicate with the DTCO 4.1x, the function control  indicates messages of the DTCO 4.1x.

**IMPORTANT**

For detailed information, please read the operating manual for your vehicle.

**► Acknowledgement of messages**

1. Press button . You have confirmed the message and the background lighting stops flashing.
2. Re-press the button . The message disappears and the previously set standard display is shown.

**Notes:**

An operating note disappears after pressing the button  for the first time. If there are several messages, you must confirm the messages one by one.



**■ Special messages****► Production status**

Fig. 132: Standard display – production status

If the DTCO 4.1x is not yet activated as the recording equipment, the “production status” is “displayed, symbol  (1).

The DTCO 4.1x accepts only the workshop card.

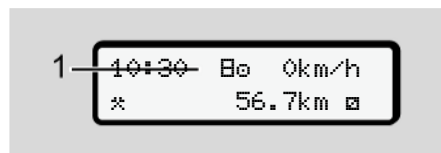
**IMPORTANT**

Have the DTCO 4.1x be put into operation properly by an authorised specialist workshop.

### ► OUT (out of scope of regulation)

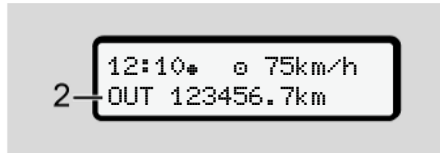

Fig. 133: Standard display – out of scope

If the vehicle is driven outside of the scope of the Regulation, the symbol **OUT** (2) is displayed.

→ *Designations* [▶ 10]

You can set this function through the menu

→ *Enter OUT start / end* [▶ 99]

By pressing any key, you can change to another display.

### ► Ferry/ train

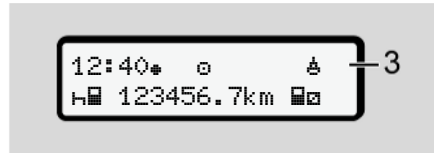

Fig. 134: Standard display – ferry/ train

If the symbol **△** (3) lights up, the vehicle is on a ferry or on a train.

You can set this function through the menu.

→ *Ferry/ train: Enter start/ end* [▶ 99].

#### IMPORTANT

Please ensure that this function and its current activity are set before the shipping process commences.

By pressing any key, you can change to a different display.

## ■ Overview of possible events

"xx" is a placeholder for the memory code in the messages.

| Message                  | Possible causes                                                                                                                                                                                                                                                        | Measure                                                                                                                                                                                                                                                        |
|--------------------------|------------------------------------------------------------------------------------------------------------------------------------------------------------------------------------------------------------------------------------------------------------------------|----------------------------------------------------------------------------------------------------------------------------------------------------------------------------------------------------------------------------------------------------------------|
| !M security breach xx    | Error in the data memory; data security in the DTCO 4.1x is no longer ensured.<br>The sensor data is no longer reliable.<br>The DTCO 4.1x housing was opened without authorisation.                                                                                    | Acknowledge message.                                                                                                                                                                                                                                           |
| !M1 security breach xx   | The card lock is disrupted or faulty.<br>The DTCO 4.1x no longer detects a tachograph card that was previously inserted correctly.<br>The identity or authenticity of the tachograph card is not in order or the data recorded on the tachograph card is not reliable. | Confirm message.<br>If the DTCO 4.1x detects security breaches which no longer guarantee the correctness of the data on the tachograph card, the tachograph card is automatically ejected – even while driving.<br>Reinsert tachograph card or get it checked. |
| !+ power interruption xx | The power was disconnected or the power supplied to the DTCO 4.1x sensor was too low or too high. This message can also be displayed when the engine is started.                                                                                                       | Acknowledge message.                                                                                                                                                                                                                                           |
| xA sensor fault          | The communication with the sensor is interrupted.<br>This message will also be displayed after a voltage interruption.                                                                                                                                                 | Acknowledge message.                                                                                                                                                                                                                                           |
| !AA motion conflict xx   | Contradiction in the evaluation of the vehicle movement between sensor and an independent signal source. The function (ferry/train) might not have been set during the shipping process.                                                                               | Confirm message.<br>Consult an authorised specialist workshop.                                                                                                                                                                                                 |



| Message                       | Possible causes                                                                                                                                                                                                                                                            | Measure                                                                                                                                                            |
|-------------------------------|----------------------------------------------------------------------------------------------------------------------------------------------------------------------------------------------------------------------------------------------------------------------------|--------------------------------------------------------------------------------------------------------------------------------------------------------------------|
| !# GNSS is missing xx         | No position data over three hours cumulative driving time.                                                                                                                                                                                                                 | Acknowledge message.                                                                                                                                               |
| !@ time conflict xx           | There is a difference of more than one minute between the time of the internal clock of the DTCO 4.1x and the time information from the GNSS signal.                                                                                                                       | Acknowledge message.                                                                                                                                               |
| !Y DSRC comm. error xx        | A communication error has occurred between the DTCO 4.1x and the external DSRC-CAN module.                                                                                                                                                                                 | Confirm message.<br>If this issue reoccurs, consult an authorised specialist workshop.                                                                             |
| !@ driving without card xx    | Driving commenced without a driver card or without a valid driver card in card drawer 1. The message is also displayed if an unauthorised card combination is inserted before or after the journey.                                                                        | Confirm message.<br>Stop vehicle and insert valid driver card.<br>If necessary, remove inserted company card/control card from the DTCO 4.1x.                      |
| !@ insertion while driving xx | The driver card was inserted after driving has begun.                                                                                                                                                                                                                      | Acknowledge message.                                                                                                                                               |
| !@ time overlap xx            | The set UTC time of this tachograph is behind the UTC time of the previous tachograph. This produces a negative time difference.                                                                                                                                           | Confirm message.<br>Identify the tachograph with the incorrect UTC time and make sure that an authorised specialist workshop inspects and corrects the tachograph. |
| !@ card not valid xx          | The tachograph card has either expired, is not yet valid, or the authentication has failed.<br>An inserted driver card which has become invalid after a change of day will be automatically written to and ejected (without request) after the vehicle becomes stationary. | Confirm message.<br>Check tachograph card and insert it again.                                                                                                     |

8

| Message                          | Possible causes                                                                                                                                                                                  | Measure                                                                                      |
|----------------------------------|--------------------------------------------------------------------------------------------------------------------------------------------------------------------------------------------------|----------------------------------------------------------------------------------------------|
| !!!1 expires in days ??          | The tachograph card expires soon.                                                                                                                                                                | Confirm message.<br>Renew tachograph card.                                                   |
| !## cards conflict xx            | The two tachograph cards must not be inserted together in the DTCO 4.1x. For example, the company card is inserted together with a control card.                                                 | Confirm message.<br>Remove the corresponding tachograph card from the card drawer.           |
| !##41 card not closed xx         | The driver card was not properly removed from the last tachograph. In some cases driver-based data will not be saved.                                                                            | Acknowledge message.                                                                         |
| >> overspeed xx                  | The set maximum speed was exceeded for longer than 60 seconds.                                                                                                                                   | Confirm message.<br>Reduce speed.                                                            |
| ##AS calibration in days ??      | The periodic inspection is due.<br>A message will appear 28 days in advance.                                                                                                                     | Confirm message.<br>Make an appointment with your workshop before the deadline.              |
| ###71 download in days ??        | The next card download is due.<br>A message will appear 14 days in advance.                                                                                                                      | Perform download of the tachograph card.                                                     |
| #! end of normal operation in ?? | The DTCO 4.1x certificate expires.<br>A message will appear 92 days in advance when removing the card.<br>The time of the message can be set with the company card and a test device or the app. | Make an appointment with your workshop to change the DTCO 4.1x before the deadline.          |
| !##? GNSS anomaly                | Manipulations or external attacks.                                                                                                                                                               | Check for manipulation reasons.<br>Check GNSS function.<br>Replace any defective components. |

## ■ Overview of possible malfunctions

"xx" is a placeholder for the memory code in the messages.

8

| Message               | Possible cause                                                                                                                                                                | Measure                                                                                                               |
|-----------------------|-------------------------------------------------------------------------------------------------------------------------------------------------------------------------------|-----------------------------------------------------------------------------------------------------------------------|
| xA internal fault xx  | Serious malfunction in the DTCO 4.1x, subsequent causes can be possible:<br>Unexpected program or process time error.                                                         | Acknowledge message.                                                                                                  |
|                       | Button elements blocked or pressed simultaneously for some time.                                                                                                              | Check proper function of the button elements.                                                                         |
|                       | Communication malfunction with external devices.                                                                                                                              | Get connecting cables or function of the external devices checked by an authorised specialist workshop.               |
|                       | Communication malfunction with the instrument display.                                                                                                                        | Have connecting cables or function of the display instrument checked by an authorised specialist workshop.            |
|                       | Malfunction at pulse output.                                                                                                                                                  | Have connecting cables or function of the connected recording equipment checked by an authorised specialist workshop. |
| xA1 internal fault xx | Malfunction in the card mechanics, e.g. card lock is not closed.                                                                                                              | Remove tachograph card and insert it again.                                                                           |
| xA time fault xx      | UTC time of the DTCO 4.1x is not plausible or does not function properly. In order to avoid an inconsistency of data, newly inserted driver / company cards are not accepted. | Acknowledge message.                                                                                                  |

8

| Message                   | Possible cause                                                                                                                                                                                                                                          | Measure                                                                                                                                                     |
|---------------------------|---------------------------------------------------------------------------------------------------------------------------------------------------------------------------------------------------------------------------------------------------------|-------------------------------------------------------------------------------------------------------------------------------------------------------------|
| x7 Printer malfunction    | The printer's supply voltage has failed or the temperature sensor for the printing head is defective.                                                                                                                                                   | Confirm message.<br>Repeat process, possibly switching off/on ignition first.                                                                               |
| x7 download fault xx      | Malfunction while downloading the data to an external device.                                                                                                                                                                                           | Confirm message.<br>Repeat data download.<br>Get connection cables (e.g. loose contact) or external device checked by an authorised specialist workshop.    |
| x1 sensor fault xx        | The sensor indicates an internal malfunction after a self-test.                                                                                                                                                                                         | Acknowledge message.                                                                                                                                        |
| x1 card fault xx          | During the reading/description process of the tachograph card, a communication malfunction has occurred, e.g. by dirty contacts.<br>The data might not be fully recorded onto the driver card.                                                          | Confirm message.<br>Clean tachograph card contacts and re-insert card.                                                                                      |
| x3 internal GNSS fault xx | An error has occurred on the GNSS - device: <ul style="list-style-type: none"> <li>• Internal device error.</li> <li>• Short circuit of an external GNSS - antenna (option).</li> <li>• No connection to the external GNSS antenna (option).</li> </ul> | Acknowledge message. Consult an authorised specialist workshop.                                                                                             |
| xY internal DSRC fault xx | An internal error on the DSRC module has occurred.<br>An error has occurred on the antenna or it is not connected.                                                                                                                                      | Confirm message.<br>Get the DSRC module and connection cables as well as the function of the external antenna checked by an authorised specialist workshop. |

| Message                     | Possible cause                                                                                            | Measure                                                        |
|-----------------------------|-----------------------------------------------------------------------------------------------------------|----------------------------------------------------------------|
| x# internal sensor fault xx | The self-test of the internal acceleration sensor has failed more than 10 times and the reset was faulty. | Confirm message.<br>Consult an authorised specialist workshop. |
| x# ITS fault xx             | An error has occurred on the internal Bluetooth component.                                                | Confirm message.<br>Consult an authorised specialist workshop. |

## ■ Driving time warnings

| Message                       | Meaning                                                                                                                                 | Measure                                                                                                     |
|-------------------------------|-----------------------------------------------------------------------------------------------------------------------------------------|-------------------------------------------------------------------------------------------------------------|
| M01 break!<br>1e04h15 #00h15  | Take a break. This message is displayed after a continuous driving time of 04:15 hours.                                                 | Confirm message.<br>Please plan a rest break soon.                                                          |
| M01 break!<br>1e04h30 #00h15  | Driving time exceeded. This message is displayed after a continuous driving time of 04:30 hours.                                        | Confirm message.<br>Take a break.                                                                           |
| M01 driving time<br>24h 03h15 | End of daily (24h), weekly (1) or bi-weekly (11) driving time is or will be reached shortly.<br>The pre-warning time can be configured. | Confirm message.<br>End your driving time and take the valid rest time in accordance with the requirements. |
| M01 rest in<br>#h 01h45       | Time for the next daily or weekly rest time is or will be reached shortly.<br>The pre-warning time can be configured.                   | Confirm message.<br>Plan your next break in a timely manner.                                                |
| Mx1 working time<br>24h 09h30 | End of daily (24h) or weekly (1) working time is or will be reached shortly.<br>The pre-warning time can be configured.                 | Confirm message.<br>End your driving time and take the valid rest time in accordance with the requirements. |
| Mx1 working time<br>x 04h15   | The end of the possible uninterrupted working time is or will be reached shortly.<br>The pre-warning time can be configured.            | Confirm message.<br>Plan your next break in a timely manner.                                                |
| M01 driving time<br>24h 03h15 | Pre-warning for reaching the maximum permitted expanded driving time.                                                                   | Observe this message. On arrival, observe the stipulated rest time.                                         |

**IMPORTANT**

The DTCO 4.1x registers, saves and calculates the driving times on the basis of the rules established by the regulation. It warns you, the driver, prematurely about exceeding your driving time.

However, these cumulative driving times do not anticipate the legal interpretation of **continuous driving time**.

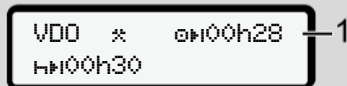
**► VDO Counter display (option)**

VDO \* 0h00h28 — 1  
h00h30

Fig. 135: VDO Counter display

After confirming the second driving time warning, the VDO counter indicates that your driving time **(1)** is complete (does not apply in case of Out of scope).

Please take a rest time immediately.

## ■ Overview of possible operational notes

| Message                       | Meaning                                                                                                                                                                                                                                                                                                                                                                                                                                                                                                                  | Measures                                                                                                                                              |
|-------------------------------|--------------------------------------------------------------------------------------------------------------------------------------------------------------------------------------------------------------------------------------------------------------------------------------------------------------------------------------------------------------------------------------------------------------------------------------------------------------------------------------------------------------------------|-------------------------------------------------------------------------------------------------------------------------------------------------------|
| ⏏ please<br>enter             | If no entry occurs during the manual entry process, this prompt is displayed.                                                                                                                                                                                                                                                                                                                                                                                                                                            | Press button  and continue the entry.                              |
| ⏏ printout not<br>possible xx | <p>A printout is not possible at the moment:</p> <ul style="list-style-type: none"> <li>• because with ADR variants, the ignition is switched off,</li> <li>• because the temperature of the thermal printing head is too high,</li> <li>• the printer interface is occupied by another active process, e.g. a printout in progress,</li> <li>• or because the supply voltage is too high or too low.</li> </ul> <p>A display is not possible at the moment because with ADR variants, the ignition is switched off.</p> | <p>You can request a printout as soon as the problem is removed.</p> <p>Switch on ignition and call the desired display again.</p>                    |
| ⏏ printout<br>delayed         | An ongoing printout is interrupted or delayed because the temperature of the thermal printing head is too high.                                                                                                                                                                                                                                                                                                                                                                                                          | Wait to cool. The printout will continue automatically as soon as the permissible state has been reached.                                             |
| ⏏ no paper<br>xx              | The printer has no paper or the printer drawer is not correctly inserted. The print request will be rejected and/or a printout in progress will be interrupted.                                                                                                                                                                                                                                                                                                                                                          | <p>Insert new roll of paper.</p> <p>Insert printer drawer correctly.</p> <p>An interrupted print process must be restarted via the menu function.</p> |



| Message                         | Meaning                                                                                                                                                                                                                                                                                                                                                                                                                 | Measures                                                                                                                                                                            |
|---------------------------------|-------------------------------------------------------------------------------------------------------------------------------------------------------------------------------------------------------------------------------------------------------------------------------------------------------------------------------------------------------------------------------------------------------------------------|-------------------------------------------------------------------------------------------------------------------------------------------------------------------------------------|
| 4.1.1 ejection not possible xx  | <p>Requesting the tachograph card will be rejected.</p> <ul style="list-style-type: none"> <li>because data might currently be read or transferred,</li> <li>the driver card needs to be read-in again within the registration time of one minute,</li> <li>a day change according to UTC time is taking place,</li> <li>the vehicle is moving,</li> <li>or with ADR variants, the ignition is switched off.</li> </ul> | <p>Wait until the DTCO 4.1x enables the function or remove the problem: Stop the vehicle or switch on the ignition. Then request the tachograph card again.</p>                     |
| 4.1.2 recording inconsistent xx | <p>There is an inconsistency in the order of the dates in the data recorded on the driver card.</p>                                                                                                                                                                                                                                                                                                                     | <p>This message can be displayed until the faulty records have been overwritten by new data.<br/>If the message is displayed permanently, get the tachograph card checked.</p>      |
| 4.1.3 please eject the card xx  | <p>An error occurred when writing data on the driver card.</p>                                                                                                                                                                                                                                                                                                                                                          | <p>While the card is ejected, a new attempt is made to communicate with the card. If this attempt also fails, a printout of the last activities saved for this card is started.</p> |
| 4.1.4 card error xx             | <p>An error has occurred when processing the inserted tachograph card. The tachograph card is not accepted and is ejected.</p>                                                                                                                                                                                                                                                                                          | <p>Clean the contacts of the tachograph card and insert it again.<br/>If the message is displayed again, check if another tachograph card is read in correctly.</p>                 |

8

| Message               | Meaning                                                                                                                                                           | Measures                                                                                                                                                                                                                                    |
|-----------------------|-------------------------------------------------------------------------------------------------------------------------------------------------------------------|---------------------------------------------------------------------------------------------------------------------------------------------------------------------------------------------------------------------------------------------|
| !1 wrong card type xx | The inserted card is not a tachograph card. The card is not accepted and is ejected.                                                                              | Insert valid tachograph card.                                                                                                                                                                                                               |
| !A internal fault xx  | Malfunction in the card mechanics, e.g. card lock is not closed.                                                                                                  | Remove tachograph card and insert it again.                                                                                                                                                                                                 |
| !A internal fault xx  | Malfunction at pulse output.                                                                                                                                      | Check connecting cables or function of the connected recording equipment.                                                                                                                                                                   |
| !A internal fault xx  | The DTCO 4.1x has a serious fault or a serious time error has occurred. For example, an unrealistic UTC time. The tachograph card is not accepted and is ejected. | Make sure that an authorized specialist workshop checks the tachograph as soon as possible and replaces it, if necessary.<br>Observe the note displayed in case of a malfunction of the tachograph.<br>→ <i>Events, malfunctions</i> [ 109] |
| !1 Please clean card! | The DTCO 4.1x has encountered problems reading or writing of the tachograph card.                                                                                 | Clean the tachograph card as well as the card drawers.<br>→ <i>Cleaning</i> [ 152]                                                                                                                                                          |

## ► Operational notes as information

| <b>Message</b>            | <b>Meaning</b>                                                                                                                                                                                                                                                                                   | <b>Measures</b>                                                                  |
|---------------------------|--------------------------------------------------------------------------------------------------------------------------------------------------------------------------------------------------------------------------------------------------------------------------------------------------|----------------------------------------------------------------------------------|
| no data!                  | It is not possible to use the menu function: <ul style="list-style-type: none"> <li>No driver card is inserted into the card drawer.</li> <li>A company card/control card is inserted into the card drawer.</li> </ul>                                                                           | These notes disappear automatically after three seconds. No steps must be taken. |
| printout started ...      | Acknowledgement of the selected function.                                                                                                                                                                                                                                                        |                                                                                  |
| entry stored              | Acknowledgement that the DTCO 4.1x saved the entry.                                                                                                                                                                                                                                              |                                                                                  |
| display not possible!     | No data can be displayed as long as the printing is in progress.                                                                                                                                                                                                                                 |                                                                                  |
| please wait!              | The tachograph card has not yet been read completely. It is not possible to call up menu functions.                                                                                                                                                                                              | These notes disappear automatically after three seconds. No steps must be taken. |
| AS calibration in days ?? | The next periodic follow-up inspection is due in the specified number of days. Required inspections due to technical changes cannot be taken into account. An authorised specialist workshop can program from what day onwards this note is displayed.<br>→ <i>Compulsory inspection</i> [▶ 152] |                                                                                  |
| 1 expires in days ??      | The released tachograph card will become invalid in the specified number of days. An authorised specialist workshop can programme from what day onwards this note is to be displayed.                                                                                                            |                                                                                  |

8

| <b>Message</b>             | <b>Meaning</b>                                                                                                                                                                                                          | <b>Measures</b> |
|----------------------------|-------------------------------------------------------------------------------------------------------------------------------------------------------------------------------------------------------------------------|-----------------|
| 📡📅1 download<br>in days ?? | The next download of the driver card data will be due in the specified number of days (default setting: 7 days).<br>An authorised specialist workshop can programme from what day onwards this note is to be displayed. |                 |

## **Print**

**Notes for printing**

**Starting print**

**Cancel print**

**Replacing the printer paper**

**Clear paper jam**

## Print

### ■ Notes for printing

#### IMPORTANT

At the start of each printout, there is an empty space of approx. 5 cm.

#### IMPORTANT

If desired, the printout can be customised with a company logo.

### ■ Starting print

#### IMPORTANT

Requirements for printing:

- The vehicle is stationary.
- With the ADR variant of the DTCO 4.1x: Ignition is switched on.
- The paper roll is inserted.
- The printer drawer is closed.

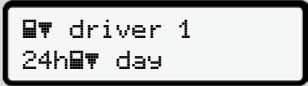

driver 1  
24h day

Fig. 136: Sample printout - Daily value



1. Use the buttons  /  and the  button to select the required menu point.
2. Select and acknowledge the day and printout type (UTC or local time).
3. Printout commences after approx. 3 seconds.  
Wait until the printout is complete.
4. Sever the printout at the cutting edge.



Fig. 137: Sever printout

#### IMPORTANT

Make sure that the card drawers are closed when tearing off a printout to avoid paper particles getting into the drawers or the card feed getting damaged.

## ■ Cancel print

- Press button **OK** again to cancel the printout early.  
The following prompt is displayed:

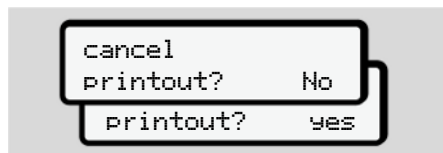

Fig. 138: Cancel print

- Select required function using buttons **▲/▼** and confirm using button **OK**.

## ■ Replacing the printer paper

### ▶ End of paper

- A coloured mark on the rear side of the printout will be displayed shortly before the paper roll is empty.
- When the paper has run out, the following message is displayed:

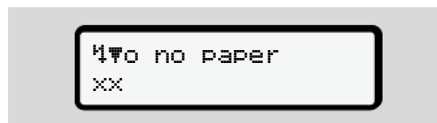

Fig. 139: Notice – no paper

- If the paper runs out during a printout: After inserting a new paper roll, restart the printout using the menu function.

## ▶ Replacing the paper roll

### IMPORTANT

Use only original VDO printer paper which bears the following markings:

- Tachograph type DTCO 4.1 or DTCO 4.1x with test mark **84**
- Approval mark **174** or **189**.



Fig. 140: Press the unlock button

9

1. Press the unlock are on the printer panel inwards.  
The printer drawer opens.

### **⚠ CAUTION**

#### **Danger of burns**

The button may be hot.

- Do not reach into the printer compartment after having removed the printer drawer.

### **IMPORTANT**

#### **Damage by objects**

To prevent the printer getting damaged:

- Do not insert any objects into the printer compartment.
2. Hold the printer drawer on both sides and pull it out of the printer.

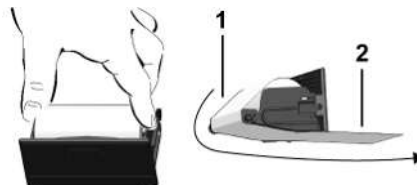

Fig. 141: Insert paper roll

3. Insert the new paper roll end down into the printer drawer.
4. Guide the paper with the part printed grey to the feed over the guide pulley (1).

### **IMPORTANT**

Make sure that the paper roll in the printer drawer does not get jammed and the start of the paper roll (2) is visible under the edge of the printer drawer (tear-off edge).

5. Push the printer drawer into the printer compartment until it engages.

The printer is ready for operation.

## **■ Clear paper jam**

In case of paper jam:

1. Open the printer drawer.
2. Separate the crumpled paper from the paper roll and remove any remaining paper from the printer drawer.
3. Reinsert the paper roll and push the printer drawer into the printer compartment until it engages.  
➔ *Replacing the printer paper* [▶ 127]



# **Printouts**

**Retaining printouts**

**Printouts (examples)**

**Explanation to the printouts**

**Data set for events or faults**

## Printouts

### ■ Retaining printouts

Take care that the printouts will not be damaged by strong light, sunlight, moisture, or heat (making them illegible).

The holder of the vehicle / the company must retain the legal printouts for at least 1 year.

### ■ Printouts (examples)

#### ▶ Daily printout of the driver card

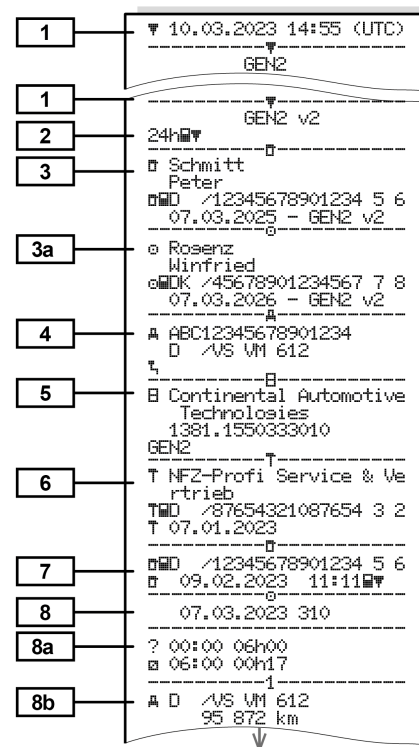

8c

8e

8a

8b

8c

8a

8c

8d

8e

8a

11

11a

```

* 06:17 00h45
* 07:02 00h39 ee
o 07:41 01h19 ee
 95 958 km: 86 km

? 09:00 00h24
 2

A S /LCR 243
 205 002 km
o 09:24 02h30 ee
* 11:54 00h39

? 12:33 00h10
 1

o 12:43 02h27
h 15:10 01h12
o 16:22 00h16
o 16:38 00h42
&+12:25
&+13:42
o 17:20 00h52
* 18:12 00h24
h 18:36 00h02
 96 177 km: 305 km

? 18:38 05h22
 Z

*+06:00 D
lat + 48°05.2'
lon + 8°26.1'
06:01
 95 872 km
+12:43 D
lat + 48°05.2'
lon + 8°26.1'
12:43
 96 177 km
09:01
:oe 09:00
lat + 48°05.2'
lon + 8°26.1'
09:01

```

11d

12

12c

13

13c

23

```

+18:38 CH
 205 408 km
o 04h54 317 km
* 02h27 o 03h29
h 01h14 ? 11h56
ee 04h28

!x#
x# 0 07.03.2023 12:45
x40 (0) 00h04
A D /VS VM 612

!# 0 07.03.2023 09:23
!34 (0) 00h01
A D /VS VM 612

A D /VS VM 612

!x#
>> 5 13.02.2023 16:42
!07 (2) 00h12
o#D /98765432109876 5 4
o#F /12345678901234 5 6

>> 4 15.02.2023 11:10
!07 (95) 00h30
o#DK /45678901234567 7 8
o#F /12345678901234 5 6

x# 0 16.02.2023 12:45
x40 (5) 00h04
o#DK /45678901234567 7 8

#* Friedrichshafen
Schmitt Peter
Reiser Winfried

```

Things to note with Daily printout of the driver card

8f

8g

8h

```

/12345678901234 5 6
07.03.2023 11:11

o
 10.03.2023 310

? 10e ?

? 00:00 06h00
o 06:00 00h17

 1

A D /VS VM 612
 95 872 km
* 06:17 00h45
* 07:02 00h39 ee
o 07:41

 km: km

Σ
*+06:00 D
 95 872 km
o 00h00 km

 10.03.2023 310

 OUT

 1

A D /VS VM 612
 95 872 km
h 00:00 07h02
* 07:02 00h39

```

► Events / faults from the driver card

1 ▼ 10.03.2023 11:11 (UTC)  
GEN2 v2

1 -----  
2 GEN2 v2  
3 !:x 80 km/h  
3 Schmitt Peter  
12345678901234 5 6  
07.03.2025 - GEN2 v2

3a Rosenz Winfried  
045678901234567 8  
03.03.2025 - GEN2 v2

4 ABC12345678901234  
D /VS VM 612

12a T  
!+ 07.03.2023 02:14  
!08 06h03  
A S /LDR 243

12c !| 07.03.2023 18:12  
!05 00h01  
A D /VS VM 612

!| 08.03.2023 08:12  
!05 00h05  
A D /S VD 432

!+ 08.03.2023 10:15  
!08 00h10  
A D /VS VM 612

!| 09.03.2023 08:45  
!09 00h01  
A D /VS VM 612

12c !| 13.02.2023 09:23  
!22 00h01  
A D /VS VM 612

12b !| 15.02.2023 16:04  
!11 01h02  
A D /VS VM 612

12c x| 22.02.2023 12:45  
x40 00h04  
A D /VS VM 612

12c x| 17.02.2023 18:02  
x40 00h03  
A D /VS VM 612

22 x| 03.02.2023 01:54  
x35 00h04  
A D /S VD 432

W  
Schmitt Peter  
Rosenz Winfried

► Daily printout of the vehicle

1 ▼ 10.03.2023 16:55 (UTC)  
GEN2 v2

2 24h

3 Schmitt Peter  
12345678901234 5 6  
07.03.2025 - GEN2 v2

4 ABC12345678901234  
D /VS VM 612

5 Continental Automotive Technologies  
1381.1550333010  
GEN2

6 T NFZ-Profi Service & Vertrieb  
TMD /87654321087654 3 2  
T 22.02.2023

7 12345678901234 5 6  
03.03.2023 11:11

9 10.03.2023  
95 872 - 96 284 km

10 95 872 km

10a H 00:00 06h17  
95 872 km 0 km

10b Rosenz Winfried  
045678901234567 8  
07.03.2026

10c A+S /LDR 243  
10.02.2023 18:54

10d 95 872 km M

10e

10g

10a

10b

10c

10d

10f

10e

10g

```

* 06:17 00h45
* 07:02 00h39 ee
o 07:41 01h19 ee

95 958 km: 86 km
o|-----
* 09:00 00h05
95 958 km: 0 km

o Mustermann
Heinz-Dieter
o|F /12345678901234 5 6
16.06.2023 GEN 2
A+D /M MS 680
07.03.2023 18:54

95 958 km
* 09:05 00h25
o 09:30 02h55
o 12:25 01h18
A+12:25
+Δ13:42
o 13:43 00h03
* 13:46 00h02 ee
o 13:48 00h45 ee
* 14:33 00h35 ee
h 15:08 01h02 ee

96 206 km: 248 km
o|-----
96 206 km
h 16:10 00h20
96 206 km: 0 km

o Anton
Max
o|A /56789567895678 9 5
10.03.2024

```

10a

10h

10a

11

11b

11c

11e

```

A+D /VS VM 612
14.02.2023 16:30
96 206 km
o 16:30 00h56
* 17:26 01h11

96 274 km: 68 km
o|-----
96 274 km
* 18:37 00h23
o 19:00 00h21
h 19:21 04h39

96 284 km: 10 km
o|-----
96 872 km
h 00:00 07h02
h 00:00 07h02

Σ
1o|-----
o 00h21 10 km
* 00h28 o 00h00
h 11h16
2o|-----
* 00h00 o 12h16
h 07h02

o Rosenz
Winfried
o|DK /45678901234567 7 8
*07:19
lat + 48° 04.1'
lon + 9° 26.5'
02.03.2023 07:19
96 274 km
h 09:00 o
95 958 km
o 09:00
lat + 48° 04.1'
lon + 9° 26.5'
09:01
o 01h19 86 km
* 01h24 o 00h00
h 03h00
ee 01h58

```

11f

13

13c

22

23

```

Γ:
D + CH
lat + 47° 66.0' o
lon + 9° 16.2' o
10.03.2023 09:36 o
134867 km

!xA
!o 1 08.03.2023 19:01
(1) 00:20
o|-----
>> 5 07.03.2023 16:42
(2) 00h12
o|D /98765432109876 5 4
o|F /12345678901234 5 6
x| 0 03.03.2023 12:45
00h04
o|DK /45678901234567 7 8

IR+
o+ 20.02.2023 14:34
+o 20.02.2023 15:29

o+ Lindau
o+ Schmitz Peter
o+
o
o
o

```

10

Things to note with Daily printout of the vehicle

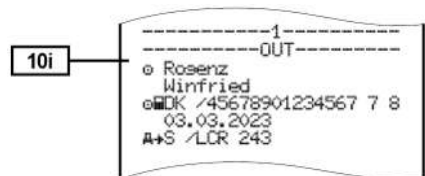

► Events / faults from the vehicle

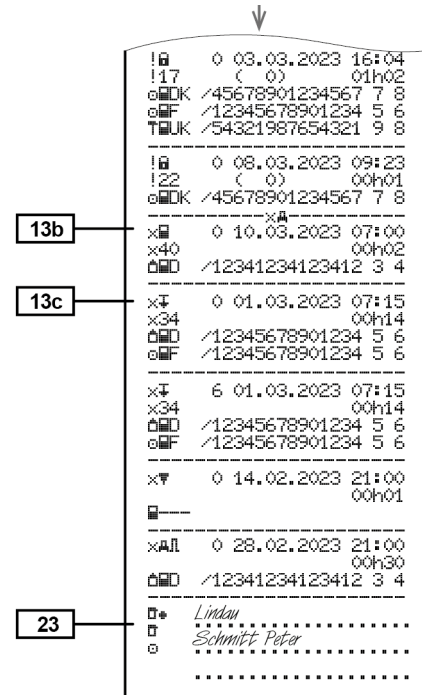
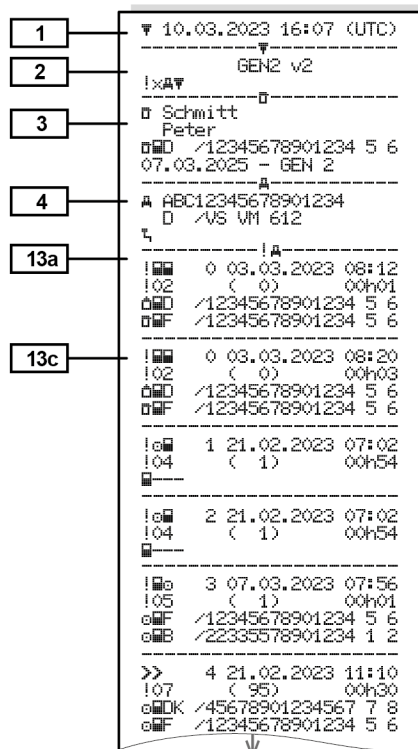

### ► Speeding events

**1** ▼ 10.03.2023 14:50 (UTC)

**2**           GE NZ v2

-----  
>> 90 km/h

**3**           ◦ Mustermann  
          Heinz-Dieter

◦ F /12345678901234 5 6  
16.06.2025 - GEN2 v2

-----

**4**           A ABC12345678901234  
          D /VS VM 612

-----

          >>>

**19**           >>03.03.2023 14:15  
          >>17.02.2023 17:44 ( 7 )

-----

**21**           >>28.02.2023 14:02 00h06  
          98 km/h 92 km/h ( 1 )

**21c**           ◦ Förster  
          Thomas

◦ D /98765432109876 5 4

-----

**21a**           >>>(365)

**21b**           >>>14.02.2023 17:10 00h15  
          94 km/h 92 km/h ( 12 )

**21c**           ◦ Mustermann  
          Heinz-Dieter

◦ F /12345678901234 5 6

-----

**23**           ••••••••••  
          ••••••••••  
          ••••••••••

*Mustermann Heinz*

### ► Technical data

**1** ▼ 10.03.2023 14:50 (UTC)

**2**           GE NZ v2

-----

**3**           ◦ Spedition Mustermann  
          D /12341234123412 3 4

**3a**           ◦ Mustermann  
          Heinz-Dieter

◦ F /12345678901234 5 6  
16.06.2025 - GEN2 v2

-----

**4**           A ABC12345678901234  
          D /VS VM 612

-----

**14**           B Continental Automotive  
          Technologies  
          H.-Hertz-Str.45 78052  
          US-Villingen  
          1381.1550333010  
          e1-84  
          1234567890  
          2023  
          GEN2 v2  
          V 41xx 03.02.2023  
          F N21-20220225

-----

**15**           I 87654321 0124 7 A1  
          e1-175  
          08.03.2023 09:15

**16**           T 87654321  
          e1-175

**16a**           Y 0011030746 0622 6 A1

**17**           T Fa. Mustermann & NFZ-  
          Hersteller  
          Schillerstr. 10 Muster  
          Kirchen

**17a**           T /45678901234567 8 9  
          07.03.2023

**17b**           T 28.03.2023 (01)  
          A ABC12345678901234

↓

W 8 000 Imp/km  
k 8 000 Imp/km  
l 3 050 mm  
! ◦ 315/70/R22.5  
> 90 km/h                      km

-----

-----  
D 07.03.2023 08:18  
B 7 BP 11223344

-----

**18**           Ie 10.03.2023 14:00  
          e 10.03.2023 15:00

**18a**           T Fa. Mustermann & NFZ-  
          Hersteller  
          Schillerstr. 10 Muster  
          Kirchen

T /45678901234567 8 9  
14.03.2025

-----

Ie 03.03.2023 13:00  
e 03.03.2023 13:26

T Kienzle ARGO GMBH  
Bismarckstr. 19 Berlin  
-Steslitz

T /89012345678901 5 6  
21.03.2025

-----

I xA 06:34  
x 09.03.2023 18:15

-----

**19**           B ATTACHMENT

**27**           S W J M  
          V xx.xx  
          E ZYY

**28**           Seal: 98765432  
          I1

**28a**           Seal: 12345678  
          S/N: 1234567890 7  
          02.2023  
          MC: A17

**2a**           T e F GEN2 v2

► Driver activities

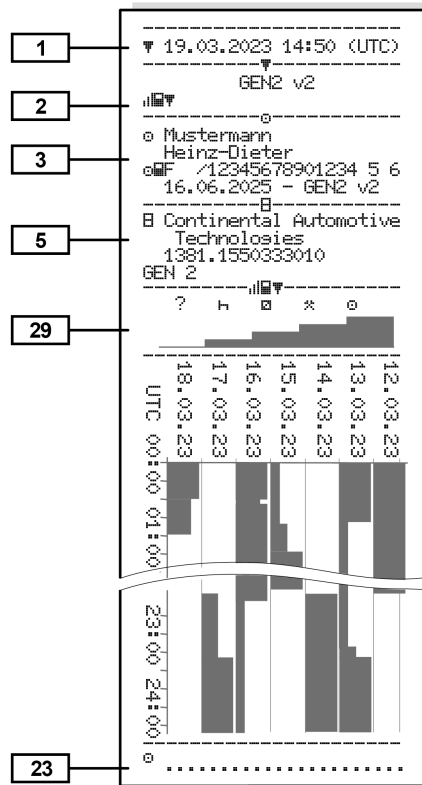

► v-diagram

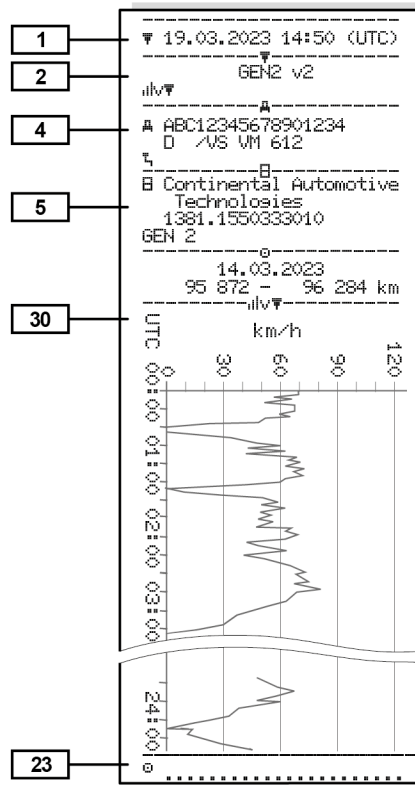

► Status D1/D2 diagram (option)

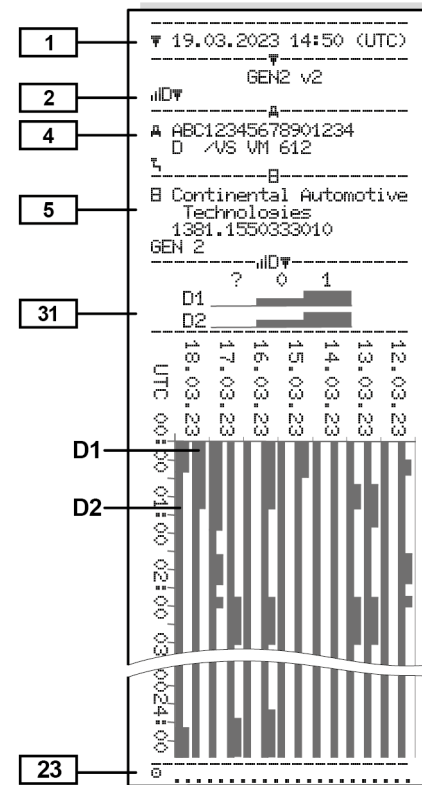



► Speed profiles (option)

1 10.03.2023 17:05 (UTC)  
 -----  
 2 GEN2 v2  
 -----  
 3 Spedition Mustermüller  
 ID /12341234123412 3 4  
 20.03.2025 - GEN2 v2  
 -----  
 4 A ABC12345678901234  
 D /VS VM 612  
 -----  
 07.03.2023 00:00  
 07.03.2023 06:17  
 -----  
 km/h

24 112 <=v< 221 00h00  
 -----  
 0 Mustermann  
 Heinz-Dieter  
 07.03.2023 18:37  
 08.03.2023 00:00  
 -----  
 km/h

25 0 <=v< 1 05h02  
 1 <=v< 10 00h01  
 10 <=v< 16 00h02  
 16 <=v< 24 00h04  
 24 <=v< 32 00h05  
 32 <=v< 40 00h05  
 40 <=v< 48 00h04  
 48 <=v< 56 00h00  
 56 <=v< 64 00h00  
 64 <=v< 72 00h00  
 72 <=v< 80 00h00  
 80 <=v< 88 00h00  
 88 <=v< 96 00h00  
 96 <=v< 104 00h00  
 104 <=v< 112 00h00  
 112 <=v< 221 00h00  
 -----  
 23 .....

► Rotation frequency profiles (option)

1 10.03.2023 17:05 (UTC)  
 -----  
 2 GEN2 v2  
 -----  
 3 Spedition Mustermüller  
 ID /12341234123412 3 4  
 20.03.2024 - GEN2  
 -----  
 4 A ABC12345678901234  
 D /VS VM 612  
 -----  
 07.03.2023 00:00  
 07.03.2023 06:17  
 -----  
 rpm

24 3281 <=n< \* 00h00  
 -----  
 0 Mustermann  
 Heinz-Dieter  
 07.03.2023 18:37  
 08.03.2023 00:00  
 -----  
 rpm

26 0 <=n< 1 05h02  
 1 <=n< 234 00h00  
 234 <=n< 469 00h00  
 469 <=n< 703 00h00  
 703 <=n< 938 00h00  
 938 <=n< 1172 00h00  
 1172 <=n< 1406 00h03  
 1406 <=n< 1641 00h03  
 1641 <=n< 1875 00h04  
 1875 <=n< 2109 00h09  
 2109 <=n< 2344 00h02  
 2344 <=n< 2578 00h00  
 2578 <=n< 2812 00h00  
 2812 <=n< 3047 00h00  
 3047 <=n< 3281 00h00  
 3281 <=n< \* 00h00  
 -----  
 23 .....

► Inserted tachograph cards

1 10.03.2023 14:50 (UTC)  
 -----  
 2 GEN2 v2  
 -----  
 3 Mustermann  
 Heinz-Dieter  
 ID /12345678901234 5 6  
 16.06.2025 - GEN2 v2  
 -----  
 32 GEN1 0000 AD  
 ID /12345678901234 5 6  
 0000513205  
 14.02.2023  
 -----  
 GEN2 0101 163  
 ID /1234567890000 0 0  
 0287705177  
 14.02.2023 18:42  
 -----  
 GEN2 v2

## ► Printout in local time

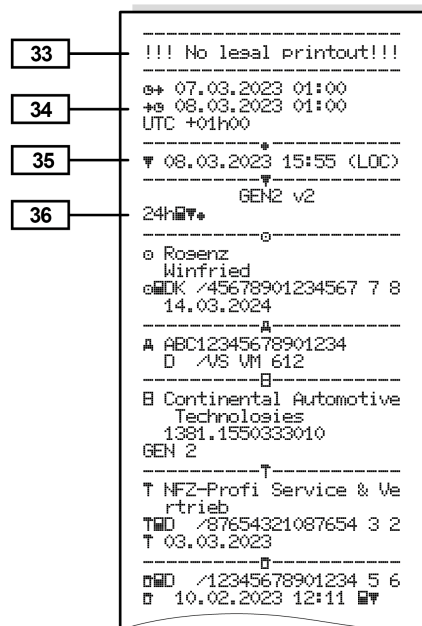

## ■ Explanation to the printouts

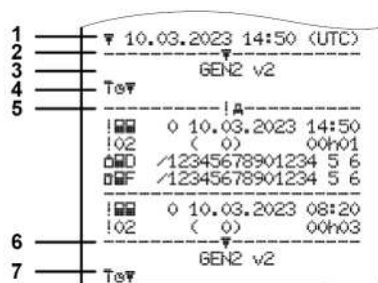

Fig. 142: Explanations to the printouts

|   |                                                                                                |
|---|------------------------------------------------------------------------------------------------|
| 1 | Printout heading with date and time (UTC)                                                      |
| 2 | Boundary line                                                                                  |
| 3 | Generation of tachograph card (from 2nd generation)                                            |
| 4 | Symbols of the selection printout (here “technical details”, for example)                      |
| 5 | Data record identifier of the respective data record                                           |
| 6 | Boundary line                                                                                  |
| 7 | Printout end symbol.<br>Again with the symbols of the selected printout (according to point 4) |

► **Key to the data blocks**

|            |                                                                                                                                                               |
|------------|---------------------------------------------------------------------------------------------------------------------------------------------------------------|
| <b>[1]</b> | <p><b>Generation of tachograph card according to Annex I B (GEN1) and Annex I C (GEN2 and GEN2 v2).</b></p> <p>Date and time of the printout in UTC time.</p> |
|------------|---------------------------------------------------------------------------------------------------------------------------------------------------------------|

**IMPORTANT**

The shown printouts to the driver cards show a case where first or second generation driver cards are inserted into the DTCO 4.1x.

Special cases:

- If a first generation driver card is inserted, the daily printout is carried out as in previous versions of the DTCO, without the identification GEN1 and GEN2.
- In case of a printout of a driver card of the second generation of a day on which cards were inserted in a DTCO 3.0 or older, all blocks (GEN1 and GEN2) are printed out, but the





GEN2 blocks are empty. For the activities, the time display is shown as **00:00**.

|            |                                                                                                                                                                                                                                                                                                                                                                                                                                                                                                                                                                                                                                                        |
|------------|--------------------------------------------------------------------------------------------------------------------------------------------------------------------------------------------------------------------------------------------------------------------------------------------------------------------------------------------------------------------------------------------------------------------------------------------------------------------------------------------------------------------------------------------------------------------------------------------------------------------------------------------------------|
| <b>[2]</b> | <p><b>Type of printout:</b></p> <ul style="list-style-type: none"> <li>• 24h□□ = Daily printout of the driver card</li> <li>• !x□□ = events/malfunctions of the driver card</li> <li>• 24h□□ = daily printout from the DTCO 4.1x</li> <li>• !x□□ = events / faults of the DTCO 4.1x</li> <li>• &gt;&gt;□ = Speeding<br/>The set value of the legally permitted maximum speed set is also printed.</li> <li>• T□□ = technical data</li> <li>• □□□ = Driver activities</li> <li>• □□□ = v-diagram</li> </ul> <p>Optional printouts:</p> <ul style="list-style-type: none"> <li>• □□□ = status D1/D2 diagram*</li> <li>• %v□ = speed profiles*</li> </ul> |
|------------|--------------------------------------------------------------------------------------------------------------------------------------------------------------------------------------------------------------------------------------------------------------------------------------------------------------------------------------------------------------------------------------------------------------------------------------------------------------------------------------------------------------------------------------------------------------------------------------------------------------------------------------------------------|

|             |                                                                                                                                                                                                                                                                                                                                                                                                                                                                                                                                                            |
|-------------|------------------------------------------------------------------------------------------------------------------------------------------------------------------------------------------------------------------------------------------------------------------------------------------------------------------------------------------------------------------------------------------------------------------------------------------------------------------------------------------------------------------------------------------------------------|
|             | <ul style="list-style-type: none"> <li>• %n = rpm profiles *</li> <li>* = Option</li> </ul>                                                                                                                                                                                                                                                                                                                                                                                                                                                                |
| <b>[2a]</b> | <b>End of printout symbol</b>                                                                                                                                                                                                                                                                                                                                                                                                                                                                                                                              |
| <b>[3]</b>  | <p><b>Information about the cardholder of the inserted tachograph card:</b></p> <ul style="list-style-type: none"> <li>□ = Controller</li> <li>⊖ = Driver</li> <li>⊕ = Contractor</li> <li>† = Workshop/Inspection body</li> <li>• Name</li> <li>• First name</li> <li>• Card identification</li> <li>• Card valid until ...</li> <li>• Generation of the tachograph card (GEN1, GEN2 or GEN2 v2)</li> </ul> <p>Note:<br/>For non-personal tachograph cards, the name of the control body, the company or the workshop is printed instead of the name.</p> |

|             |                                                                                                                                                                                                                              |                                                                                                                                                                                                                     |                                                                                                                                                                                                                                                 |
|-------------|------------------------------------------------------------------------------------------------------------------------------------------------------------------------------------------------------------------------------|---------------------------------------------------------------------------------------------------------------------------------------------------------------------------------------------------------------------|-------------------------------------------------------------------------------------------------------------------------------------------------------------------------------------------------------------------------------------------------|
| <b>[3a]</b> | <b>Information about the cardholder of the other tachograph card</b>                                                                                                                                                         | <ul style="list-style-type: none"> <li>• Date, time and type of the control</li> <li>☑ = Download the driver card</li> <li>☒ = Download from the DTCO 4.1x</li> <li>☐ = Print</li> <li>□ = display</li> </ul>       | <b>[8b] Insertion of driver card into drawer (card drawer -1 or card drawer 2):</b> <ul style="list-style-type: none"> <li>• Authorising member state and vehicle registration number</li> <li>• Odometer reading when card inserted</li> </ul> |
| <b>[4]</b>  | <b>Vehicle identification:</b> <ul style="list-style-type: none"> <li>• Vehicle identification number</li> <li>• Authorizing member state and vehicle registration number</li> <li>• Standard load of the vehicle</li> </ul> | <b>[8] List of all driver activities in the order they appear:</b> <ul style="list-style-type: none"> <li>• Calendar day of the printout and the usage meter (number of days that the card was used)</li> </ul>     | <b>[8c] Activities of the driver card:</b> <ul style="list-style-type: none"> <li>• Start and duration as well as driving status</li> <li>☑☑ = crew operation</li> </ul>                                                                        |
| <b>[5]</b>  | <b>Identification of the 4.1x :</b> <ul style="list-style-type: none"> <li>• Tachograph manufacturer</li> <li>• Part number of the DTCO 4.1x</li> <li>• Generation of the vehicle unit (GEN1, GEN2)</li> </ul>               | <b>[8a] ? = Time period that the card was not inserted:</b> <ul style="list-style-type: none"> <li>• Manually entered activities after insertion of the driver card, with pictogram, start and duration.</li> </ul> | <b>[8d] Specific conditions:</b> <ul style="list-style-type: none"> <li>• Time of entry and pictogram for example: Ferry or train</li> </ul>                                                                                                    |
| <b>[6]</b>  | <b>Most recent calibration of the 4.1x :</b> <ul style="list-style-type: none"> <li>• Name of workshop</li> <li>• Workshop identification</li> <li>• Date of calibration</li> </ul>                                          | <b>[8a1] ☐☐ = Type of load at start of the day</b> <ul style="list-style-type: none"> <li>• If the card is inserted into the DTCO 4.1x, otherwise empty</li> </ul>                                                  | <b>[8e] Withdrawal of driver card:</b> <ul style="list-style-type: none"> <li>• Odometer reading and distance travelled since most recent insertion</li> </ul>                                                                                  |
| <b>[7]</b>  | <b>Most recent control:</b> <ul style="list-style-type: none"> <li>• Control card identification</li> </ul>                                                                                                                  |                                                                                                                                                                                                                     | <b>[8f] Warning:</b> Possible inconsistency in the data recording since this day was saved twice on the tachograph card                                                                                                                         |
|             |                                                                                                                                                                                                                              |                                                                                                                                                                                                                     | <b>[8g] Activity not complete:</b>                                                                                                                                                                                                              |

|              |                                                                                                                                                                                                                                      |              |                                                                                                                                                                                                     |              |                                                                                                                                                                                                                                               |
|--------------|--------------------------------------------------------------------------------------------------------------------------------------------------------------------------------------------------------------------------------------|--------------|-----------------------------------------------------------------------------------------------------------------------------------------------------------------------------------------------------|--------------|-----------------------------------------------------------------------------------------------------------------------------------------------------------------------------------------------------------------------------------------------|
|              | <ul style="list-style-type: none"> <li>Duration of activity and daily summaries might be given incompletely when printouts are made while the driver card is inserted</li> </ul>                                                     |              | <ul style="list-style-type: none"> <li>Odometer reading at the end of the time period and distance travelled</li> </ul>                                                                             | <b>[10f]</b> | <b>Entry time and pictogram of a specified condition:</b> <ul style="list-style-type: none"> <li>⚓➔ = start ferry/train</li> <li>➔⚓ = end ferry/train</li> <li>OUT➔ = start (recording equipment not required)</li> <li>➔OUT = end</li> </ul> |
| <b>[8h]</b>  | <b>The specific condition "OUT of scope" was switched on at start of the day</b>                                                                                                                                                     | <b>[10b]</b> | <b>Insertion of the driver card:</b> <ul style="list-style-type: none"> <li>Last name of driver</li> <li>First name of driver</li> <li>Card identification</li> <li>Card valid until ...</li> </ul> | <b>[10g]</b> | <b>Withdrawal of driver card:</b> <ul style="list-style-type: none"> <li>Odometer reading and distance travelled</li> </ul>                                                                                                                   |
| <b>[9]</b>   | <b>Start of list of all driver activities in the 4.1x:</b> <ul style="list-style-type: none"> <li>Calendar day of the printout</li> <li>Odometer readings at the times 00:00 and 23:59</li> </ul>                                    | <b>[10c]</b> | <ul style="list-style-type: none"> <li>Authorising member state and registration number of the previous vehicle</li> <li>Date and time card was removed from the previous vehicle</li> </ul>        | <b>[10h]</b> | <b>Chronology of all activities from card drawer 2</b>                                                                                                                                                                                        |
| <b>[10]</b>  | <b>Chronology of all activities from card drawer 1</b>                                                                                                                                                                               | <b>[10d]</b> | <ul style="list-style-type: none"> <li>Odometer reading when inserting the driver card<br/>M = a manual entry was carried out</li> </ul>                                                            | <b>[10i]</b> | <b>The specific condition "Out of scope" was switched on at start of the day</b>                                                                                                                                                              |
| <b>[10a]</b> | <b>Time period in which no driver card was inserted in card drawer 1:</b> <ul style="list-style-type: none"> <li>Odometer reading at the start of the time period</li> <li>Set activity or activities in this time period</li> </ul> | <b>[10e]</b> | <b>List of activities:</b> <ul style="list-style-type: none"> <li>Pictogram of the activity, start and length as well as driving status</li> <li>☐☐ = crew operation</li> </ul>                     | <b>[11]</b>  | <b>Daily summary</b>                                                                                                                                                                                                                          |
|              |                                                                                                                                                                                                                                      |              |                                                                                                                                                                                                     | <b>[11a]</b> | <b>Entered locations:</b> <ul style="list-style-type: none"> <li>⚓ ⚓ = start time with country and region, if required (Spain)</li> <li>⚓ ⚓ = end time with country and region, if required (Spain)</li> </ul>                                |







|                                                                              |                                                                                                                                                                                                                                                              |                     |                                                                                                                                                                                                                                                                                                                                                                                                                                                                                                                                                            |                                                                                                                                                                                                                                                                                                                                                                                                                                                                                                                                                                                                                                                                                                                              |                                                                                            |
|------------------------------------------------------------------------------|--------------------------------------------------------------------------------------------------------------------------------------------------------------------------------------------------------------------------------------------------------------|---------------------|------------------------------------------------------------------------------------------------------------------------------------------------------------------------------------------------------------------------------------------------------------------------------------------------------------------------------------------------------------------------------------------------------------------------------------------------------------------------------------------------------------------------------------------------------------|------------------------------------------------------------------------------------------------------------------------------------------------------------------------------------------------------------------------------------------------------------------------------------------------------------------------------------------------------------------------------------------------------------------------------------------------------------------------------------------------------------------------------------------------------------------------------------------------------------------------------------------------------------------------------------------------------------------------------|--------------------------------------------------------------------------------------------|
| <ul style="list-style-type: none"> <li>• Vehicle odometer reading</li> </ul> | <p><b>Position data (only for second generation driver cards)</b></p> <ul style="list-style-type: none"> <li>• Chronological listing of position data at start and end of working time as well as after every three hours cumulative driving time</li> </ul> | <p><b>[11d]</b></p> | <p><b>Daily summary "Total value of activities" from the driver card</b></p> <ul style="list-style-type: none"> <li>• Total driving time and distance travelled</li> <li>• Total working and standby time</li> <li>• Total rest time and unknown time</li> <li>• Total time in crew activities</li> </ul>                                                                                                                                                                                                                                                  | <ul style="list-style-type: none"> <li>•  = Load with time and position data</li> <li>•  = Unload with time and position data</li> <li>• Position data (chronological), after every 3 hours cumulative driving time and up to shift end (here only shift end)</li> <li>• Activities from this driver with: <ul style="list-style-type: none"> <li>– Total driving time and distance travelled,</li> <li>– total working time and total availability time,</li> <li>– total rest time,</li> <li>– total time in crew activities.</li> </ul> </li> </ul> |                                                                                            |
| <p><b>[11b]</b></p>                                                          | <p><b>Summary of times with no driver card in card drawer 1:</b></p> <ul style="list-style-type: none"> <li>• Entered locations in chronological order (no entry in example)</li> <li>• Total activities from card drawer 1</li> </ul>                       | <p><b>[11e]</b></p> | <p><b>Summary of the activities, chronologically arranged by driver (cumulative for each driver for both card drawers):</b></p> <ul style="list-style-type: none"> <li>• Last name, first name, card identification of the driver</li> <li>•  = start time with country and region, if necessary (Spain)</li> <li>•  = end time with country and region, if necessary (Spain)</li> </ul> | <p><b>[11f]</b></p>                                                                                                                                                                                                                                                                                                                                                                                                                                                                                                                                                                                                                                                                                                          | <p><b>Position data border crossing</b></p>                                                |
| <p><b>[11c]</b></p>                                                          | <p><b>Summary of times with "no driver card" in card drawer 2:</b></p> <ul style="list-style-type: none"> <li>• Entered locations in chronological order (no entry in example)</li> <li>• Total activities from card drawer 2</li> </ul>                     |                     |                                                                                                                                                                                                                                                                                                                                                                                                                                                                                                                                                            | <p><b>[12]</b></p>                                                                                                                                                                                                                                                                                                                                                                                                                                                                                                                                                                                                                                                                                                           | <p><b>List of the five most recent saved events or malfunctions on the driver card</b></p> |

|              |                                                                                                                                                                                                                                                                                                                                                                                                                                                   |                                                                                                                                                                                                                                                                                        |                                                                                                                                                                                                                                                                                                                                                                                                                                                                                                                                                                                                                                                                                               |
|--------------|---------------------------------------------------------------------------------------------------------------------------------------------------------------------------------------------------------------------------------------------------------------------------------------------------------------------------------------------------------------------------------------------------------------------------------------------------|----------------------------------------------------------------------------------------------------------------------------------------------------------------------------------------------------------------------------------------------------------------------------------------|-----------------------------------------------------------------------------------------------------------------------------------------------------------------------------------------------------------------------------------------------------------------------------------------------------------------------------------------------------------------------------------------------------------------------------------------------------------------------------------------------------------------------------------------------------------------------------------------------------------------------------------------------------------------------------------------------|
| <b>[12a]</b> | <b>List of all saved events on the driver card, arranged according to type of malfunction and date</b>                                                                                                                                                                                                                                                                                                                                            | <ul style="list-style-type: none"> <li>• Authorising member state and registration number of the vehicle in which the events or malfunctions appeared.</li> </ul>                                                                                                                      | <p><i>Line 2:</i></p> <ul style="list-style-type: none"> <li>• Events subject to security breach are broken down with an additional code<br/>See "Coding for more detailed description"</li> <li>• Number of similar events on that day<br/>See "Number of similar events"</li> <li>• Duration of the event or malfunction</li> </ul> <p><i>Line 3:</i></p> <ul style="list-style-type: none"> <li>• Identification of the driver cards inserted at the start or at the end of the event or the malfunction (maximum of four entries)</li> <li>• --- is displayed if no driver card is inserted</li> </ul> |
| <b>[12b]</b> | <b>List of all saved malfunctions on the driver card, arranged according to type of malfunction and date</b>                                                                                                                                                                                                                                                                                                                                      | <b>[13]</b> <b>List of the last five saved or still active events/malfunctions of the DTCO 4.1x</b>                                                                                                                                                                                    | <b>[14]</b> <b>Identification of the tachograph:</b> <ul style="list-style-type: none"> <li>• Tachograph manufacturer</li> </ul>                                                                                                                                                                                                                                                                                                                                                                                                                                                                                                                                                              |
| <b>[12c]</b> | <b>Data record of the event or malfunction</b><br><i>Line 1:</i> <ul style="list-style-type: none"> <li>• Pictogram of the event or malfunction</li> <li>• Date and start</li> </ul> <i>Line 2:</i> <ul style="list-style-type: none"> <li>• Events subject to security breach are broken down with an additional code<br/>See "Data record for events or malfunctions"</li> <li>• Duration of the event or malfunction</li> </ul> <i>Line 3:</i> | <b>[13a]</b> <b>List of all recorded or continuing events in the DTCO 4.1x</b>                                                                                                                                                                                                         |                                                                                                                                                                                                                                                                                                                                                                                                                                                                                                                                                                                                                                                                                               |
|              |                                                                                                                                                                                                                                                                                                                                                                                                                                                   | <b>[13b]</b> <b>List of all recorded or continuing faults in the DTCO 4.1x</b>                                                                                                                                                                                                         |                                                                                                                                                                                                                                                                                                                                                                                                                                                                                                                                                                                                                                                                                               |
|              |                                                                                                                                                                                                                                                                                                                                                                                                                                                   | <b>[13c]</b> <b>Data record of the event or malfunction</b><br><i>Line 1:</i> <ul style="list-style-type: none"> <li>• Pictogram of the event or malfunction</li> <li>• Coding of data record purpose.<br/>See "data record for events or faults"</li> <li>• Date and start</li> </ul> |                                                                                                                                                                                                                                                                                                                                                                                                                                                                                                                                                                                                                                                                                               |

|              |                                                                                                                                                                                                                                                                                                                         |                                                                                                                                                                  |                                                                                                                                                                                                                                                                                                                                                                                                                                                                                                                                                                                                     |                                                                                                                                                                                                                                                                                              |
|--------------|-------------------------------------------------------------------------------------------------------------------------------------------------------------------------------------------------------------------------------------------------------------------------------------------------------------------------|------------------------------------------------------------------------------------------------------------------------------------------------------------------|-----------------------------------------------------------------------------------------------------------------------------------------------------------------------------------------------------------------------------------------------------------------------------------------------------------------------------------------------------------------------------------------------------------------------------------------------------------------------------------------------------------------------------------------------------------------------------------------------------|----------------------------------------------------------------------------------------------------------------------------------------------------------------------------------------------------------------------------------------------------------------------------------------------|
|              | <ul style="list-style-type: none"> <li>• Address of the tachograph manufacturer</li> <li>• Part number</li> <li>• Type approval number</li> <li>• Serial number</li> <li>• Year of manufacture</li> <li>• Version and date of installation of the user software</li> <li>• Version of the saved digital card</li> </ul> | <ul style="list-style-type: none"> <li>• Name and address of the workshop</li> <li>• Workshop identification</li> <li>• Workshop card valid until ...</li> </ul> | <ul style="list-style-type: none"> <li>– 80 = serial number of the new KITA seal</li> <li>– 81 = Ability of the use of tachograph cards of the first generation is suppressed</li> <li>– 82 = replacement of the motion sensor</li> <li>– 83 = replacement of the remote communication module</li> <li>– 84 = Configured as an intelligent tachograph version 2 with full OS-NMA functionality</li> </ul>                                                                                                                                                                                           |                                                                                                                                                                                                                                                                                              |
| <b>[15]</b>  | <b>Identification of the sensor:</b> <ul style="list-style-type: none"> <li>• Serial number</li> <li>• Type approval number</li> <li>• Date/time of the last coupling with the DTCO 4.1x</li> </ul>                                                                                                                     | <b>[17b]</b>                                                                                                                                                     | <ul style="list-style-type: none"> <li>• Date and purpose of the calibration: <ul style="list-style-type: none"> <li>– 01 = activation; recording of known calibration data at the time of activation</li> <li>– 02 = first installation, first calibration data after activating the DTCO 4.1x</li> <li>– 03 = installation after repair – replacement device; first calibration data in the current vehicle</li> <li>– 04 = periodic inspection</li> <li>– 05 = entry of the registration number by the company</li> <li>– 06 = time adjustment without Calibration (GNSS)</li> </ul> </li> </ul> | <ul style="list-style-type: none"> <li>• Vehicle identification number</li> <li>• Authorizing member state and registration number</li> <li>• <math>w</math> = Distance pulse count of the vehicle</li> <li>• <math>k</math> = set constant in the DTCO 4.1x for speed adjustment</li> </ul> |
| <b>[16]</b>  | <b>Identification of the GNSS module</b>                                                                                                                                                                                                                                                                                |                                                                                                                                                                  |                                                                                                                                                                                                                                                                                                                                                                                                                                                                                                                                                                                                     |                                                                                                                                                                                                                                                                                              |
| <b>[16a]</b> | <b>Identification of the DSRC</b>                                                                                                                                                                                                                                                                                       |                                                                                                                                                                  |                                                                                                                                                                                                                                                                                                                                                                                                                                                                                                                                                                                                     |                                                                                                                                                                                                                                                                                              |
| <b>[17]</b>  | <b>Calibration data</b>                                                                                                                                                                                                                                                                                                 |                                                                                                                                                                  |                                                                                                                                                                                                                                                                                                                                                                                                                                                                                                                                                                                                     |                                                                                                                                                                                                                                                                                              |
| <b>[17a]</b> | <b>Listing of the calibration data (in data records):</b>                                                                                                                                                                                                                                                               |                                                                                                                                                                  |                                                                                                                                                                                                                                                                                                                                                                                                                                                                                                                                                                                                     |                                                                                                                                                                                                                                                                                              |



|              |                                                                                                                                                                                                                                                                                                                                                                                                                                   |                                                                                                                      |                                                                                                                                                                                                                                       |                                                                          |                                                                                                                                                                                                                                                    |
|--------------|-----------------------------------------------------------------------------------------------------------------------------------------------------------------------------------------------------------------------------------------------------------------------------------------------------------------------------------------------------------------------------------------------------------------------------------|----------------------------------------------------------------------------------------------------------------------|---------------------------------------------------------------------------------------------------------------------------------------------------------------------------------------------------------------------------------------|--------------------------------------------------------------------------|----------------------------------------------------------------------------------------------------------------------------------------------------------------------------------------------------------------------------------------------------|
|              | <ul style="list-style-type: none"> <li>• 1 = actual circumference of tyres</li> <li>• ☼ = Tyre size</li> <li>• &gt; = legally permitted maximum speed</li> <li>• Old and new odometer reading</li> <li>• ☼ / ¼ / ? = standard type of vehicle load</li> <li>• Country in which the calibration was performed, as well as date and time</li> <li>• ☼ = Seal data (up to 5 seal data records, 1 line for each seal used)</li> </ul> | <ul style="list-style-type: none"> <li>• Workshop identification</li> <li>• Workshop card valid until ...</li> </ul> | <b>[21]</b>                                                                                                                                                                                                                           | <b>First instance of over-speeding since the most recent calibration</b> |                                                                                                                                                                                                                                                    |
| <b>[18]</b>  | <b>Time settings</b>                                                                                                                                                                                                                                                                                                                                                                                                              | <b>[18b]</b>                                                                                                         | <b>Note:</b>                                                                                                                                                                                                                          | <b>[21a]</b>                                                             | <b>The five most serious cases of speeding in the last 365 days</b>                                                                                                                                                                                |
| <b>[18a]</b> | <b>Listing of all available data about time setting:</b>                                                                                                                                                                                                                                                                                                                                                                          | <b>[19]</b>                                                                                                          | <b>The most recently recorded event and the current malfunction:</b>                                                                                                                                                                  | <b>[21b]</b>                                                             | <b>The 10 most recently recorded instances of speeding.</b>                                                                                                                                                                                        |
|              | <ul style="list-style-type: none"> <li>• Date and time, old</li> <li>• Date and time, changed</li> <li>• Name of workshop that set the time</li> <li>• Address of workshop</li> </ul>                                                                                                                                                                                                                                             |                                                                                                                      | <ul style="list-style-type: none"> <li>! = Most recent event, date, and time</li> <li>× = Most recent malfunction, date, and time</li> </ul>                                                                                          |                                                                          | For each day the most severe instance of speeding is recorded.                                                                                                                                                                                     |
|              |                                                                                                                                                                                                                                                                                                                                                                                                                                   | <b>[20]</b>                                                                                                          | <b>Information on speeding control:</b>                                                                                                                                                                                               | <b>[21c]</b>                                                             | <b>Entries in cases of speeding (in chronological order after highest Ø speed):</b>                                                                                                                                                                |
|              |                                                                                                                                                                                                                                                                                                                                                                                                                                   |                                                                                                                      | <ul style="list-style-type: none"> <li>• Date and time of the most recent control</li> <li>• Date and time of the first instance of speeding since the most recent control and the number of subsequent speeding instances</li> </ul> |                                                                          | <ul style="list-style-type: none"> <li>• Date, time, and duration of speeding</li> <li>• Highest speed and Ø speeding, number of similar events on that day</li> <li>• Last name of driver</li> <li>• Card identification of the driver</li> </ul> |

|      |                                                                                                                                                                                                                                                                                                                                                                                                                                                                                                                                                                                                                                                          |                                                                                                                                                                                                                                                                                                                                                                                                                                                                                                                                                                                                                                                                                 |                                                                                                                                                                                                                                                                                                                                                                                                                                                                                                                                                                                                                                               |
|------|----------------------------------------------------------------------------------------------------------------------------------------------------------------------------------------------------------------------------------------------------------------------------------------------------------------------------------------------------------------------------------------------------------------------------------------------------------------------------------------------------------------------------------------------------------------------------------------------------------------------------------------------------------|---------------------------------------------------------------------------------------------------------------------------------------------------------------------------------------------------------------------------------------------------------------------------------------------------------------------------------------------------------------------------------------------------------------------------------------------------------------------------------------------------------------------------------------------------------------------------------------------------------------------------------------------------------------------------------|-----------------------------------------------------------------------------------------------------------------------------------------------------------------------------------------------------------------------------------------------------------------------------------------------------------------------------------------------------------------------------------------------------------------------------------------------------------------------------------------------------------------------------------------------------------------------------------------------------------------------------------------------|
|      | <p>Note:<br/>If within a block no data set exists for a case of speeding, &gt;&gt;--- is displayed.</p>                                                                                                                                                                                                                                                                                                                                                                                                                                                                                                                                                  |                                                                                                                                                                                                                                                                                                                                                                                                                                                                                                                                                                                                                                                                                 |                                                                                                                                                                                                                                                                                                                                                                                                                                                                                                                                                                                                                                               |
| [22] | <p><b>Periods with activated remote control:</b></p> <ul style="list-style-type: none"> <li>•  = Start time</li> <li>•  = End time</li> </ul> <p>Note:<br/>Recording is made separately for driver 1 and driver 2. The times of both drivers are indicated on the printout, even when they are the same.</p>                                                                                                                                                                           | <ul style="list-style-type: none"> <li>• Last name of driver</li> <li>• First name of driver</li> <li>• Card identification</li> </ul> <p>Note:<br/>Missing information about the cardholder means: no driver card inserted in card drawer 1.</p> <ul style="list-style-type: none"> <li>• start of the profile recording with date and time</li> <li>• End of the profile recording with date and time</li> </ul> <p>New profiles are created:</p> <ul style="list-style-type: none"> <li>• by inserting/removing a tachograph card in card drawer 1,</li> <li>• by a day change,</li> <li>• by a correction of the UTC time,</li> <li>• by a voltage interruption.</li> </ul> | <ul style="list-style-type: none"> <li>• Area: <math>0 \leq v &lt; 1</math> = vehicle is stationary</li> </ul> <p>The speed profile is divided into 16 zones. During installation, the individual ranges can be adjusted individually.</p>                                                                                                                                                                                                                                                                                                                                                                                                    |
| [23] | <p><b>Handwritten information:</b></p> <ul style="list-style-type: none"> <li>•  = Location of control</li> <li>•  = Signature controller</li> <li>•  = Start time</li> <li>•  = End time</li> <li>•  = Signature driver</li> </ul> | [25]                                                                                                                                                                                                                                                                                                                                                                                                                                                                                                                                                                                                                                                                            | [26]                                                                                                                                                                                                                                                                                                                                                                                                                                                                                                                                                                                                                                          |
| [24] | <p><b>Information about the cardholder of the recorded profile:</b></p>                                                                                                                                                                                                                                                                                                                                                                                                                                                                                                                                                                                  | <p><b>Recording of speed profiles:</b></p> <ul style="list-style-type: none"> <li>• List of the defined speed ranges and period in this range</li> </ul>                                                                                                                                                                                                                                                                                                                                                                                                                                                                                                                        | [27]                                                                                                                                                                                                                                                                                                                                                                                                                                                                                                                                                                                                                                          |
|      |                                                                                                                                                                                                                                                                                                                                                                                                                                                                                                                                                                                                                                                          |                                                                                                                                                                                                                                                                                                                                                                                                                                                                                                                                                                                                                                                                                 | <p><b>Recording of rpm profiles:</b></p> <p>List of defined engine rotation frequency areas and period in this area:</p> <ul style="list-style-type: none"> <li>• Area: <math>0 \leq n &lt; 1</math> = motor off</li> <li>• Range: <math>3281 \leq n &lt; x</math> = unlimited</li> </ul> <p>The rpm profile is divided into 16 zones. During installation, the individual ranges can be adjusted individually.</p> <p><b>Manufacturer-specific data:</b></p> <ul style="list-style-type: none"> <li>• Version number of the software upgrade module (SWUM)</li> <li>• Example: 04.01.40 R024</li> <li>• T = Test software version</li> </ul> |

|        |                                                                                                                                                                                                                                                                                                                                                             |        |                                                                                                                                                                                                                                                                                                                                    |  |                                                                                                                                                                                       |                                                                                                                                                                                 |
|--------|-------------------------------------------------------------------------------------------------------------------------------------------------------------------------------------------------------------------------------------------------------------------------------------------------------------------------------------------------------------|--------|------------------------------------------------------------------------------------------------------------------------------------------------------------------------------------------------------------------------------------------------------------------------------------------------------------------------------------|--|---------------------------------------------------------------------------------------------------------------------------------------------------------------------------------------|---------------------------------------------------------------------------------------------------------------------------------------------------------------------------------|
|        | <ul style="list-style-type: none"> <li>• R = Official sample or end version of the software</li> </ul>                                                                                                                                                                                                                                                      |        | <ul style="list-style-type: none"> <li>• Month and year of production</li> <li>• Manufacturer code</li> </ul>                                                                                                                                                                                                                      |  | <ul style="list-style-type: none"> <li>• Legend of the symbols</li> <li>• From the selected day on, there are profiles of status inputs D1/D2 of the last 7 calendar days.</li> </ul> |                                                                                                                                                                                 |
| [28]   | <b>Number of the housing seal on the DTCO 4.1x</b>                                                                                                                                                                                                                                                                                                          |        |                                                                                                                                                                                                                                                                                                                                    |  |                                                                                                                                                                                       |                                                                                                                                                                                 |
| [28a]  | <p><b>Sensor-specific data:</b></p> <ul style="list-style-type: none"> <li>• Serial number of sensor</li> <li>• Extended serial number and equipment type</li> <li>• Month and year of production</li> <li>• Manufacturer code</li> </ul> <p>NOTE:<br/>Serial number and design approval number of the motion sensor are only printed after activation.</p> | [28 c] | <p><b>Seals</b></p> <ul style="list-style-type: none"> <li>• Manufacturer code</li> <li>• Seal number</li> <li>• Location of sealing                             <ul style="list-style-type: none"> <li>– 7 = sensor to the transmission, e.g. KITAS 4.0 2185</li> <li>– 12 = M1N1 adapter with the vehicle</li> </ul> </li> </ul> |  | [32]                                                                                                                                                                                  | <b>Chronological listing of inserted driver cards</b>                                                                                                                           |
| [28 b] | <p><b>DCRC module</b></p> <ul style="list-style-type: none"> <li>• Serial number of the DSRC module</li> <li>• Device type                             <ul style="list-style-type: none"> <li>– 6 = DTCO</li> <li>– 9 = external DSRC module</li> </ul> </li> </ul>                                                                                         | [29]   | <p><b>Recording of the activities:</b></p> <ul style="list-style-type: none"> <li>• Legend of the symbols</li> <li>• From the selected day, a diagram showing the activities of the last seven calendar days is created</li> </ul>                                                                                                 |  | [33]                                                                                                                                                                                  | <p>Please note: No authorised printout.</p> <p>According to the Regulation (e.g. retention requirement), a printout in local time is invalid</p>                                |
|        |                                                                                                                                                                                                                                                                                                                                                             | [30]   | <p><b>Recording of the course of speed on the selected day</b></p>                                                                                                                                                                                                                                                                 |  | [34]                                                                                                                                                                                  | <p><b>Period of the printout in local time:</b></p> <p>☐+ = start of recording</p> <p>+☐ = end of recording</p> <p>UTC +01h00 = difference between UTC time and local time.</p> |
|        |                                                                                                                                                                                                                                                                                                                                                             | [31]   | <p><b>Recording of additional work groups, such as use of blue light, siren etc.:</b></p>                                                                                                                                                                                                                                          |  | [35]                                                                                                                                                                                  | <b>Date and time of the printout in local time (LOC).</b>                                                                                                                       |
|        |                                                                                                                                                                                                                                                                                                                                                             |        |                                                                                                                                                                                                                                                                                                                                    |  | [36]                                                                                                                                                                                  | <b>Type of printout, e.g. in local time „B“</b>                                                                                                                                 |

## ■ Data set for events or faults

For each established event or each established fault, the DTCO 4.1x will register and save the data according to the specified rules.

|   |                                      |
|---|--------------------------------------|
| 1 | !EF /12345678901234 5 6              |
| 2 | >> 4 10.09.2023 11:10<br>( 45) 00h30 |
| 3 | !EF /12345678901234 1 2              |

- (1) Purpose of the data set
- (2) EventFaultType according to Annex I C
- (3) Number of similar events on that day

The data record purpose (1) indicates why the event or fault was recorded. Events of similar type which occur several times on the same day, are shown on position (2).

The following overview shows the events and faults arranged according to error type (cause) and the assignment of the data record purpose:

→ Coding of data set purpose [▶ 148]

→ Number of similar events [▶ 149]

Events which constitute a safety violation „!E“ are broken down using an additional coding (1 in table below):

→ Coding for more detailed description [▶ 150]

## ► Coding of data set purpose

The following overview shows the events and faults, arranged according to error type (cause) and the assignment of the data record purpose.

| Pictogram | Cause                                          | Purpose   |
|-----------|------------------------------------------------|-----------|
| !E        | Card conflict <sup>2)</sup>                    | 0         |
| !E        | Driving without appropriate card <sup>2)</sup> | 1 / 2 / 7 |
| !E        | Insertion while driving                        | 3         |
| !E        | Card not closed                                | 0         |
| >>        | Speed too high <sup>2)</sup>                   | 4 / 5 / 6 |
| !E        | Voltage interruption                           | 1 / 2 / 7 |
| !E        | Sensor malfunction                             | 1 / 2 / 7 |
| !E        | Movement conflict <sup>4)</sup>                | 1 / 2     |
| !E        | Security breach                                | 0         |
| !E        | Time overlap <sup>1)</sup>                     | -         |
| !E        | Card invalid <sup>3)</sup>                     | -         |

tab. 1: Events

| Pictogram | Cause                   | Purpose |
|-----------|-------------------------|---------|
| ✖         | Card fault              | 0       |
| ✖         | Internal fault          | 0 / 6   |
| ✖         | Printer fault           | 0 / 6   |
| ✖         | Faults during down-load | 0 / 6   |
| ✖         | Sensor malfunction      | 0 / 6   |

tab. 2: Malfunctions

- 1) This event will be saved only on the driver card.
- 2) This event / fault will only be saved in the DTCO 4.1x.
- 3) This event is not stored by the DTCO 4.1x.
- 4) This event / fault will be saved in the DTCO 4.1x and on the second generation driver card.

## Overview Data record purpose

| Purpose | Meaning                                                                       |
|---------|-------------------------------------------------------------------------------|
| 0       | One of the most recent event or malfunction.                                  |
| 1       | The longest event of one of the last 10 days on which an event occurred.      |
| 2       | One of the five longest events in the last 365 days.                          |
| 3       | The last event of one of the last 10 days on which an event occurred.         |
| 4       | The most serious event of one of the last 10 days on which an event occurred. |
| 5       | One of the 5 most serious events in the last 365 days.                        |
| 6       | The first event or the first malfunction after the last calibration.          |
| 7       | An active event or an ongoing malfunction.                                    |

## Number of similar events

| Purpose | Meaning                                                                   |
|---------|---------------------------------------------------------------------------|
| 0       | For this event, it is not necessary to save "Number of similar events".   |
| 1       | An event of this type appeared on this day.                               |
| 2       | Two events of this type appeared on this day, but only one was saved.     |
| n       | On this day, n events of this type have occurred and only one was stored. |

### ► Coding for more detailed description

|       |                    |
|-------|--------------------|
| ! 122 | 0 10.03.2023 09:23 |
| A D   | /VS WM 612 00h01   |
| ! 116 | 0 07.03.2023 16:04 |
| A D   | /VS WM 612 01h02   |

Fig. 143: Coding explanations

Events which are subject to a safety violation are broken down using an additional coding (1).

### Security breaching codes on the DTCO 4.1x

| Code | Meaning                                                                          |
|------|----------------------------------------------------------------------------------|
| 10   | No additional information                                                        |
| 11   | Failed authentication of the sensor                                              |
| 12   | Authentication errors of the driver cards                                        |
| 13   | Unauthorised changes to the sensor                                               |
| 14   | Integrity error; the authenticity of the data on the driver card is not assured. |
| 15   | Integrity error, the authenticity of the saved user data is not assured.         |
| 16   | Internal data transmission error                                                 |
| 18   | Manipulation of the hardware                                                     |
| 19   | Manipulation detection with GNSS                                                 |

### Safety-breaching attempts on the impulse sensor

| Code | Meaning                                                              |
|------|----------------------------------------------------------------------|
| 20   | No additional information                                            |
| 21   | Failed authentication                                                |
| 22   | Integrity error, the authenticity of the memory data is not assured. |
| 23   | Internal data transmission error                                     |
| 24   | Unauthorised opening of the casing                                   |
| 25   | Manipulation of the hardware                                         |

# Maintenance and inspection obligation

Cleaning

Compulsory inspection

## Maintenance and inspection obligation

### ■ Cleaning

#### ▶ Cleaning the DTCO 4.1x

- Clean the DTCO 4.1x with a lightly dampened cloth or a microfibre cleaning cloth.
- If necessary, clean the card drawers with a suitable cleaning card → *Cleaning cards and cleaning wipes* [▶ 175]

Both can be obtained from your Distribution & Service Center.

#### ATTENTION

##### Avoid damage

- Do not use any abrasive cleaning agents and not solvents or petrol.

#### ▶ Cleaning tachograph card

- Clean any dirty tachograph contacts with a lightly moistened cloth or a microfibre cleaning cloth.

The latter is available at your competent Sales & Service Centre.

#### ATTENTION

##### Avoid damage

Do not use solvents or petrol to clean the tachograph contacts.

### ■ Compulsory inspection

Preventive maintenance work is not required for the DTCO 4.1x.

- However, have the proper functioning of the DTCO 4.1x checked at least every two years by an authorised workshop.

Inspections are required if the following points have occurred:

- Changes have been made to the vehicle, e.g. to the distance pulse count or the tyre circumference.
- Repairs were carried out on the DTCO 4.1x.
- The registration number of the vehicle has changed.
- The UTC time deviates by more than 20 minutes.



** ATTENTION****For inspections, please note**

- Make sure that the calibration plaque is renewed during every inspection and that it contains the required data.

**IMPORTANT**

Faulty entry in the KITAS 4.0 2185

- A power cut can result in a faulty entry in the KITAS 4.0 2185.

## Troubleshooting

**Data backup by the workshop**

**Overvoltage/undervoltage**

**Error card communication**

**Printer drawer defect**

**Automatic ejection of tachograph card**

## Troubleshooting

### ■ Data backup by the workshop

The authorised workshops can download the data from the DTCO 4.1x and pass it on to the company.

If the data download is not possible, the workshops are instructed to certify this to the contractor accordingly.

#### **⚠ ATTENTION**

##### **Data backup**

- Archive the data or carefully keep the documentation for possible requests by control bodies.

### ■ Overvoltage/undervoltage

Supply voltages of the DTCO 4.1x which are too low or too high are shown in the standard display (a):

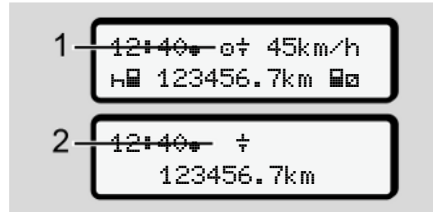

Fig. 144: Display - Fault in the supply voltage

#### **IMPORTANT**

If one of the card drawers is open during an over or undervoltage, do not insert a tachograph card.

### Case 1: ⚡ (1) Overvoltage

#### **IMPORTANT**

In case of overvoltage the display is switched off and the buttons are locked.

The DTCO 4.1x continues to save activities. The functions printing or display of data and the insertion or withdrawal of a tachograph card are not possible.

### Case 2: ⚡ (2) Low voltage

This case corresponds to a power interruption.

The standard display is shown.

The DTCO 4.1x cannot fulfil its role as a recording equipment! The driver's activities will not be recorded.

► **Power interruption**

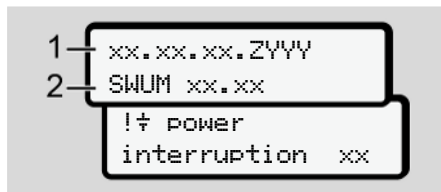

Fig. 145: Display – voltage interruption

After a voltage interruption, for approx. 5 seconds, the version of the operating software (1) and the version of the software upgrade module (2) are displayed.

Then, the DTCO 4.1x signals:  
!⚡ powerinterruption xx.

**⚠ ATTENTION**

**Continuous display of ⚡**

- If the ⚡ symbol is displayed continuously with correct on-board voltage: Consult an authorised specialist workshop.
- When the DTCO 4.1x is defective, you are obligated to note activities with handwritten entries.  
➔ *Recording activities manually* [ 60]

■ **Error card communication**

If an error has occurred in the card communication, the driver is requested to remove their card.



Fig. 146: Display - Eject card

To do this, press the **OK** button.

While the card is ejected, a new attempt is made to communicate with the card. If this attempt also fails, a printout of the last activities saved for this card is started.

**IMPORTANT**

With this printout, the driver can still document his activities.

The printout must be signed by the driver.

The driver can add all activities on the printout (except for driving times) until the driver card is inserted again.

**IMPORTANT**

The driver can create a daily printout of the vehicle unit and add and sign his additional activities until the driver card is inserted again.

**IMPORTANT**

For extended absences – e.g. During a daily of weekly rest time – the driver card should be removed from the card drawer.

**■ Printer drawer defect**

If the printer drawer is defect, it can be replaced.

- Contact an authorised specialist workshop.

**■ Automatic ejection of tachograph card**

If the DTCO 4.1x recognises a fault in the card communication, it tries to transfer the existing data to the tachograph card.

The driver is informed of the fault by the message  please eject the card xx and prompted to remove the driver card.

The printout of the activities last saved for the driver card is performed automatically.

→ *Recording activities manually* [▶ 60]

## **Technical data**

**DTCO 4.1x**

**Paper roll**

**Technical data****■ DTCO 4.1x**

|                             |                                                                                                                        |
|-----------------------------|------------------------------------------------------------------------------------------------------------------------|
| DTCO 4.1x                   |                                                                                                                        |
| Measurement range end value | 220 km/h (according to Annex I C )<br>250 km/h (for other vehicle uses)                                                |
| LC display                  | 2 lines with 16 characters each                                                                                        |
| Temperature                 | Operational: -20°C to +70°C<br>storage: -20 °C to +75 °C                                                               |
| Voltage                     | 12 V DC or 24 V DC                                                                                                     |
| Ground                      | 600 g ± 50 g                                                                                                           |
| Power consumption           | Standby: 12 V: max. 30 mA; 24 V: max. 20 mA<br>operational: 12 V: max. 5,0 A; 24 V: max. 4,2 A                         |
| EMV/ EMC                    | ECE R10                                                                                                                |
| Thermal printing mechanism  | Character size: 2.1 x 1.5 mm<br>Print width: 24 characters/row<br>speed: ca. 15 – 30 mm/sec.<br>printout of pictograms |
| Protection type             | IP 54                                                                                                                  |

13

|                          |                                                                                       |
|--------------------------|---------------------------------------------------------------------------------------|
| DTCO 4.1x Ex version     |                                                                                       |
| Ex zone                  | Vehicle unit: Zone 2<br>interface to the motion sensor: Zone 1                        |
| Device group             | II<br>Vehicle unit:: Device group 3<br>interface to the motion sensor: Device group 2 |
| Gas group                | IIC                                                                                   |
| Ignition protection type | Vehicle unit: ec<br>interface to the motion sensor: ib ib                             |
| Temperature class        | T6<br>Operational: -20 °C to +65 °C                                                   |



### ■ Paper roll

|                          |                                                                                                                 |
|--------------------------|-----------------------------------------------------------------------------------------------------------------|
| Environmental conditions | Temperature: -25 °C to +70 °C                                                                                   |
| Dimensions               | Diameter: approx. 27.5 mm<br>Width: 56.5 mm<br>Length: approx. 8 m                                              |
| Order no.                | 1381.90030300<br>The original replacement paper rolls can be obtained from your local sales and service center. |



**IMPORTANT**

Use only original VDO printer paper which bears the following markings:

- Tachograph type DTCO 4.1 or DTCO 4.1x with test mark  **84**
- Approval mark  **174** or  **189**.

## **Appendix**

**Declaration of conformity/Authorisations**

**Optional accessories**

**VDO online shop**

## Appendix

### ■ Declaration of conformity/ Authorisations

Under link <https://fleet.vdo.com/support/ce-certificates/> includes the following explanations and authorisations:

- KBA type approval (Kraftfahrt-Bundesamt = German Federal Vehicle Office)
- ATEX type examination certificate
- CE Declaration of conformity
- UKCA Declaration of conformity

### EU Declaration of Conformity

- 1. Equipment**  
1a. Smart tachograph type DTCC 1381
- 2. Manufacturer**  
Continental Automotive Technologies GmbH  
Heinrich-Hertz-Str. 45,  
78952 Villingen-Schwenningen  
Germany
- 2a.** We as manufacturer hereby declare that the following described equipment when used for its intended purpose is in conformity with the relevant Union harmonization legislation: Directive No. 2014/53/EU (RED Directive) and if applicable Directive No. 2014/34/EU for equipment and protective systems for use in potentially explosive atmospheres. This declaration of conformity is issued under the sole responsibility of the manufacturer.
- 3. Variants of the Equipment**  
**3a.** Variants with GNSS and DSRC:  
DTCC 1381.xxxxx1X  
DTCC 1381.xxxxx2X  
DTCC 1381.xxxxx3X  
**3b.** variants with GNSS only:  
DTCC 1381.xxxxx4X  
DTCC 1381.xxxxx5X  
DTCC 1381.xxxxx6X  
**3c.** variants for ADR vehicles:  
DTCC 1381.2xxxxxx  
DTCC 1381.3xxxxxx  
DTCC 1381.4xxxxxx  
DTCC 1381.7xxxxxx
- 4. EU type examination certificate**  
T818402F-05-TEC  
4a. Only applicable for RED certification (variants 3a. and 3b.)
- 5. Notified body**  
TÜV 03 ATEX 2324 X  
4b. Only applicable for ADR variants (3c.)  
**5a.** Only applicable for RED certification (variants 3a. and 3b.):  
CTC advanced GmbH, Untertuerkheimer Str. 6-10,  
66117 Saarbrücken, Germany, CE 0062.  
**5b.** Only applicable for EU type examination of ADR variants (3c.):  
TUV NORD CERT GmbH, Geschäftsstelle Hannover, Am TÜV 1,  
30519 Hannover, Germany, CE 0044
- 6. Marking of the equipment**  
**6a.** Notified body of surveillance of ADR variants:  
DEKRA Testing and Certification GmbH, Zertifizierungsstelle Bochum,  
Dinnenthalstraße 9, 44808 Bochum CE 0158
- 6a.** Only applicable for ADR variants (3c.):  
 II 3(2)/S Ex ec [ib Gg] IIC T6 Gc
- 7. Used harmonized standards**  
**7a.** Applicable for the above mentioned variants (3a. and 3b.) according **RED Directive**.  
EN 300 328 V2.2.2, EN 300 674-2-2 V2.1.1, EN 303 413 V1.2.1

1/2

Continental Automotive Technologies GmbH | Continental-Platz 1, 30173 Hannover | P.O. Box 1 001 | 30001 Hannover  
Tel. +49 511 938-0 | Fax +49 511 938-17000 | CE017001700  
Company registration: Hannover (Register Court: Amtsgericht Hannover) | HRB: 3095 | VAT number: DE254141096  
Managing Director: Nicola Pöcher | Other: Frank Stäger, Ingrid Stahmann  
Bank: Continental AG | BIC: CTG1333 | Account no.: 5605010001 | Sort code: 56050100

Fig. 147: EU Declaration of Conformity – 1



EN 301 489-1 V2.2.3, EN 301 489-3 V2.3.0 (Draft), EN 301 489-17 V2.2.5 (Draft), EN 301 489-19 V2.2.1  
 EN 62368-1:2014/AC:2015/A11:2017/AC:2017  
 EN 62479:2010

7b. Only applicable for ADR variants (3c.):

EN IEC 60079-0:2018;  
 EN IEC 60079-7:2015/A1;  
 EN 60079-11:2012

**8. Other used directives and regulations**  
 VO (EU) Nr. 165/2014, VO (EU) 2016/799, VO (EU) 2016/502, ECE R10 Rev. 06/02

Villingen-Schwenningen, August 22, 2024  
 Continental Automotive Technologies GmbH

Pierre Böher  
 Head of Homologation

*Pierre Böher*  
 Head of Homologation

Rothe, Ulrich  
 Head of Quality

*Rothe, Ulrich*  
 Head of Quality

Digitally signed by Pierre Böher, DN: cn=Pierre Böher, o=Continental Automotive Technologies GmbH, ou=Continental Automotive Technologies GmbH, email=pierre.boeher@continental-automotive.com

**9. This declaration certifies the conformity to the specified directives but does not imply any warranty for properties. The safety documentation accompanying the product shall be considered in detail.**



<https://www.fleet.vdo.com/support/ce-certificates/>

Continental Automotive Technologies GmbH | Carl-Benz-Str. 1 | 71734 Heilbronn | P.O. Box 1 061 | 74001 Heilbronn  
 Tel: +49 (0) 71 33 03 0 | Fax: +49 (0) 71 33 03 1770 | [info@continental-automotive.com](mailto:info@continental-automotive.com)  
 Continental Automotive Sales, Inc. | 11000 Springdale Court | Arlington Heights, IL 60018 | USA | VAT number: DE254146706  
 Continental Automotive Sales (UK) Limited | 10000 Lakeside Drive | Frimley, Surrey GU10 2PH | UK | VAT number: GB254146706  
 Managing Director: Nicole Reiner, Tobias Frennberg, Dr. Andreas Lutz, Frank Stäger, Jerald Stalhamm  
 Managing Director: Ralf Schmitt | CEO: Frank Hees | President: Dr. Stefan Jansen | Cont. no.: 30070901 | Cont. no.: 30070901  
 BSW: DE254146706

Fig. 148: EU Declaration of Conformity – 2



ANNEX (eng / deu / bul / est / fin / ell / spa / fra / ger / ita / hrv / lit / lav / nd / pol / por / rom / swe / slk / sl / che / is / tur / srp / se / mkd / bos)

(eng) EU Declaration of Conformity

1. Equipment / la Smart tachograph type DTCCO 1381 / 2. Manufacturer / 2a. We as manufacturer hereby declare that the following described equipment when used for its intended purpose is in conformity with the relevant Union harmonization legislation: Directive No. 2014/53/EU (RED Directive) and if applicable Directive No. 2014/34/EU for equipment and protective systems for use in potentially explosive atmospheres. This declaration of conformity is issued under the sole responsibility of the manufacturer. / 3. Variants of the Equipment / 3a. Variants with GNS5 and DSRC / 3b. variants with GNS5 only / 3c. variants for ADR variants / 4. EU type examination certificate / 4a. 5b. Only applicable for RED certification / 4b. 5b. 7b. Only applicable for ADR variants / 5. Notified body / 5b. of EU type examination / 5c. of surveillance / 6. Other used directives and regulations / 6. This declaration certifies the conformity to the specified directives but does not imply any warranty for properties. The safety documentation accompanying the product shall be considered in detail.

(deu) EU-Konformitätserklärung

1. Gerät / 1a. Intelligenter Fahrtenschreiber Typ DTCCO 1381 / 2. Hersteller / 2a. Wir erklären hiermit als Hersteller, dass die nachstehend beschriebene Einrichtung die bestimmungsgemäße Verwendung der Anforderungen der Richtlinie Nr. 2014/53/EU (RED Richtlinie) und wenn anwendbar die Anforderungen der Richtlinie Nr. 2014/34/EU für Geräte und Schutzsysteme zur Vermeidung in explosionsgefährdeten Umgebungen erfüllt. Diese Konformitätserklärung wird unter der alleinigen Verantwortung des Herstellers ausgestellt. / 3. Varianten des Gerätes / 3a. Varianten mit GNS5 und DSRC / 3b. Varianten mit GNS5 / 3c. Varianten für ADR-Varianten / 4. EU-Baumusterprüfbescheinigung / 4a. 5b. Nur für die Zulassung nach RED / 4b. 5b. 7b. Nur für die Zulassung nach ADR-Varianten / 5. Benannte Stelle / 5b. der EU-Baumusterprüfung / 5c. der Überwachung / 6. Geltungsbereich / 6. Diese Erklärung bescheinigt die Übereinstimmung mit den genannten Richtlinien, ist jedoch keine Beschaffenheits- oder Haltbarkeitsgarantie nach §443 BGB. Die Sicherheitsheftnisse der jeweiligen Produktdokumentation sind zu beachten.

(bul) EC декларация за съответствие

1. Оборудване / 1a. Интелигентен тахограф тип DTCCO 1381 / 2. Производител / 2a. Ние, в качеството си на производител, декларираме, че описаното по-долу оборудване, когато се използва по предназначение, е в съответствие със съответното законодателство на Съюза за хармонизация. Декларация № 2014/53/ЕС (RED директива) и, ако е приложимо, Декларация № 2014/34/ЕС за оборудване и защитни системи за използване в потенциално експлозивна атмосфера. Настоящата декларация за съответствие е издадена на отговорност на производителя. / 3. Варианти на оборудването / 3a. Варианти с GNS5 и DSRC / 3b. варианти само с GNS5 / 3c. варианти за различни средства ADR / 4. Сертификат за ЕС одобрение на типа / 4a. 5b. Препоръчително само за RED одобрение / 4b. 5b. 7b. Препоръчително само за одобрение ADR / 5. Известна институция / 5b. за одобрение на типа / 5c. за наблюдение / 6. Други използвани директиви и регламенти / 6. Тази декларация удостоверява съответствието с посочените директиви, но не представлява извадка гаранция за съответствие. Документацията за безопасност, придружаваща продукта, трябва да се разглежда подробно.

(est) EU vastavusdeklaratsioon

1. Seadmed / 1a. Nutikõrvaldajad DTCCO 1381 / 2. Tootja / 2a. Tõlgime kinnitama käesolevaga, et allpool kirjeldatud seadme vastavalt sellele ettenähtud otstarbeks kasutamisel seadmesüsteemi liitu, ühildussüsteemide dünaamiliste, direktiivide nr 2014/53/EU (RED-direktiiv) ja vajaduse korral direktiivide nr 2014/34/EU raamdirektiivide nõuetele vastavalt kasutamisel seadme ja kaitsesüsteemide süsteemid on vastavalt Euroopa Liidu õigusaktidele. See deklaratsioon on koostatud tootja ühele vastutusele. / 3. Seadme variandid / 3a. Variantid koos GNS5 ja DSRC-ga / 3b. variantid ainult ADR-variantide puhul / 4a. 5b. Kõikjal kehtivaks ainult RED-sertifikaadi puhul / 4b. 5b. 6b. 7b. Kõikjal kehtivaks ainult ADR-variantide puhul / 5. Teavitatud asutus / 5b. EU tüübikinnituse / 5c. järelvaatuse / 6. Seadme omadused / 6. See deklaratsioon kinnitab vastavust määratud standardite / 7a. Kehtivusele vastavalt RED-direktiivile / 8. Muud kasutatud direktiivid ja määrused / 9. Käesolev deklaratsioon tõendab vastavust nimetatud direktiivide, kuid ei tähenda mingit garantiid omandajale kohta. Ühisolekuvõtteid tuleb arvestada tootja kaasolevate ohutusdokumentatsiooniga.

(fin) EU:n vastavusilmoitus

1. Laitteet / 1a. Älykkäis ajoneuvon tyyppi DTCCO 1381 / 2. Valmistaja / 2a. Vahvistame siin, et allpool kirjeldatud seadme, mille alljärgnevalt loetleme, kasutamisel selle eesmärgel, milleks see on mõeldud, vastab Euroopa Liidu õigusaktidele. See deklaratsioon on koostatud tootja ühele vastutusele. / 3. Seadme variandid / 3a. Variantid koos GNS5 ja DSRC-ga / 3b. variantid ainult ADR-variantide puhul / 4a. 5b. Kõikjal kehtivaks ainult RED-sertifikaadi puhul / 4b. 5b. 6b. 7b. Kõikjal kehtivaks ainult ADR-variantide puhul / 5. Teavitatud asutus / 5b. EU tüübikinnituse / 5c. järelvaatuse / 6. Seadme omadused / 6. See deklaratsioon kinnitab vastavust määratud standardite / 7a. Kehtivusele vastavalt RED-direktiivile / 8. Muud kasutatud direktiivid ja määrused / 9. Käesolev deklaratsioon tõendab vastavust nimetatud direktiivide, kuid ei tähenda mingit garantiid omandajale kohta. Ühisolekuvõtteid tuleb arvestada tootja kaasolevate ohutusdokumentatsiooniga.

Continental AG, Hagen, Germany, 51515, Germany  
Tel: +49 201 8100-0, Fax: +49 201 8100-110, E-Mail: info@continental-tires.com  
Continental Tyres (UK) Limited, Watlington Road, Watlington, Oxford, OX12 9BA, UK  
Continental Tyres (Ireland) Limited, Kesh, Carrickmacross, Co. Wick, Ireland  
Managing Director, Nicola Weiner, Sales Director, Tobias Frank, Head of Sales, Michael  
Tel: +49 201 8100-0, Fax: +49 201 8100-110, E-Mail: info@continental-tires.com  
BMW, DZS-2023-03-01-00000000

Fig. 149: EU Declaration of Conformity – 3















Process):  
**DEKRA Testing and Certification GmbH, Zertifizierungsstelle**  
 Bochum, Dinnendahlstraße 9, 44809 Bochum CE 0158

Only applicable for ADR variants:

⊗ II 3 (2) G Ex ec [ib Gb] IIC T6 Gc

Applicable for the above mentioned variants according Radio  
 Equipment Regulations 2017 (SI 2017 No. 1206, as amended):

EN 300 328 V2.2.2, EN 300 674-2-2 V2.1.1, EN 303 413 V1.2.1  
 EN 301 488-1 V2.3, EN 301 489, 3 V2.3.0 (Draft), EN 301 489-  
 17 V3.2.5 (Draft), EN 301 489-19 V2.2.1

EN 62368-1: 2014/AC: 2015/A11: 2017/AC:2017

EN 62479:2010

Applicable for the above mentioned ADR variants according  
 Potentially Explosive Atmospheres Regulations 2016 (UKSI  
 2016 No. 1107):

EN IEC 60079-0:2018;  
 EN IEC 60079-7:2015/A1:2018;  
 EN 60079-11:2012

**Other used directives and  
 regulations**  
 Regulation (EU) No. 165/2014, Regulation (EU) 2016/799, ECE  
 R10 Rev. 08/02

Villingen-Schwenningen, the August 15, 2024  
 Continental Automotive Technologies GmbH

Pierre Bühler  
 Head of Homologation

Ulrich Rothe  
 Head of Quality

The declaration certifies the conformity to the specified directives and regulations but does not imply any warranty for properties. The safety documentation  
 accompanying the product must be considered in detail.



<https://www.fleet.vdo.com/support/ce-certificates/>

2/2

Continental Automotive Technologies GmbH | Conference Place 1, 70174 Heilbronn | P.O. Box 1 001 | 70071 Heilbronn  
 Tel: +49 (0)511 930-0 | Fax: +49 (0)511 930-1770 | www.continental-automotive.com  
 Chairman of the Supervisory Board: Wolfgang Huber  
 Chairman of the Board of Directors: Klaus Frenck  
 Bank details: Deutsche Bank, Frankfurt | BIC: 25020033 | IBAN: DE25 2502 0033 0000 0000 0000 0000  
 Bank: DE2502003300000000000000

Fig. 155: UKCA Declaration of Conformity – 2

## ■ Optional accessories

### ▶ DLK Smart Download Key



You can use the DLK Smart download key to legally download and archive data from the DTCO 4.1x.

Uploading the data into the VDO Fleet Online Portal is optionally possible.

Order number: **2910003149100**

### ▶ DLKPro Download Key S



You can use the DLKPro download key S to legally download and archive data from the DTCO 4.1x.

Order number: **2910002165200**

### ▶ DLKPro Compact S



Using the DLKPro Compact S, you can legally download, archive and visualise data from the DTCO 4.1x and from the driver card.

Order Numbers:

- Europa – **2910002165300**
- Europa (EE) – **2910002165400**

**► Remote DL 4G**

Using the Remote DL 4G of VDO, you can transfer download data via GPRS to your fleet management system or an evaluation software.

Order number: **2910002759400**

**► VDO Link**

VDO Link is an add-on module to invoke vehicle and tachograph data remotely and in real time, e.g. for telematics and toll recording.

VDO Link is attached to the DTCO.

**Validity:**

- Telematics are available from DTCO 4.1
- Toll recording is available from DTCO 4.1a

Order number: **AAA2201870110**

### ► Cleaning cards and cleaning wipes

Use the cleaning cards to clean the card drawers with the DTCO 4.1x .

The cleaning wipes serve for the cleaning of your driver and/or company cards.

Order Numbers:

- Cleaning cards (12 cards):  
**A2C5951338266**
- Cleaning wipes (12 wipes):  
**A2C5951184966**
- Set of cleaning wipes (6 cards/ 6 wipes):  
**A2C5951183866**

### ■ VDO online shop

The online shop for VDO products and services is located at:  
[www.fleet.vdo.com](http://www.fleet.vdo.com).

## **Change overview**

**Release overview**



Change overview

■ Release overview

These operating instructions are valid for the following DTCO version:

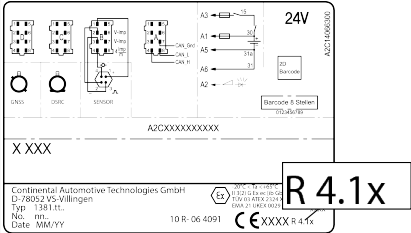
| Release status                                                                                                                                                                                                                                                                                                                                                                                               | Operating instructions      | Modification of the operating manual |
|--------------------------------------------------------------------------------------------------------------------------------------------------------------------------------------------------------------------------------------------------------------------------------------------------------------------------------------------------------------------------------------------------------------|-----------------------------|--------------------------------------|
|  <p>24V</p> <p>AZCXXXXXXXXXX</p> <p>X XXX</p> <p>Confidential Automotive Technologies GmbH<br/>             D-7802 Züschen-Villingen<br/>             Typ 138111<br/>             NG: ...<br/>             Date: MM/YY</p> <p>10 R: 06 4091</p> <p>CE XXXX R 4.1x</p> <p>Current release: See printout "Technical data"</p> | <p>BA00.1381.41 100 102</p> | <p>First release</p>                 |

15

| Release status | Operating instructions | Modification of the operating manual                                                                                                                                                                                                                                                                                                                                                                                                                                                                                                                                                                                                                                                                                                                                                                                                         |
|----------------|------------------------|----------------------------------------------------------------------------------------------------------------------------------------------------------------------------------------------------------------------------------------------------------------------------------------------------------------------------------------------------------------------------------------------------------------------------------------------------------------------------------------------------------------------------------------------------------------------------------------------------------------------------------------------------------------------------------------------------------------------------------------------------------------------------------------------------------------------------------------------|
|                | BA00.1381.41 100 102   | <p>Version DTCO 4.1a</p> <ul style="list-style-type: none"> <li>• Extending the scope to DTCO 4.1 and DTCO 4.1a</li> <li>• Updating some DTCO example screens</li> <li>• General editorial changes. QR code and document index updated (last page)</li> <li>• Description of the optional function "Centralised language" added<br/> → <i>Centralised language (option)</i> [▶ 106]</li> <li>• Description of the in-vehicle Bluetooth connection, Bluetooth devices management, Bluetooth configuration added<br/> → <i>In-vehicle Bluetooth connection</i> [▶ 101]<br/> → <i>Managing Bluetooth devices</i> [▶ 103]<br/> → <i>Bluetooth configuration</i> [▶ 103]</li> <li>• VDO Link added as an optional device<br/> → <i>VDO Link</i> [▶ 174]</li> <li>• Toll pictogram added</li> <li>• Operating software version extended</li> </ul> |

**IMPORTANT**

For the release status of the tachograph, please see the printout "*Technical data*".

**IMPORTANT**

This instruction manual is not suitable for older versions of the DTCO.

**Index****A**

|                                     |        |
|-------------------------------------|--------|
| Abort entry .....                   | 58     |
| Access Rights .....                 | 30     |
| Activities                          |        |
| adding - when card inserted .....   | 55     |
| Enter and add rest time .....       | 64     |
| Addition                            |        |
| Manual entry .....                  | 63     |
| manually - when card inserted ..... | 54     |
| ADR variant .....                   | 20, 25 |
| Registration number .....           | 20     |
| AETR Agreement .....                | 10     |
| ATEX Certificate .....              | 163    |
| Authorisations .....                | 163    |

**B**

|                       |    |
|-----------------------|----|
| Bluetooth .....       | 24 |
| Symbol .....          | 20 |
| to pair .....         | 97 |
| Border crossing ..... | 33 |
| manually .....        | 57 |
| Brightness .....      | 23 |

**C**

|                                         |        |
|-----------------------------------------|--------|
| Cabotage .....                          | 61     |
| Calibration .....                       | 27     |
| Card                                    |        |
| Handling .....                          | 50     |
| plug .....                              | 47     |
| remove .....                            | 49     |
| request .....                           | 63     |
| Card drawer .....                       | 20, 23 |
| CE Explanation .....                    | 163    |
| Centralised language .....              | 106    |
| Certificate - message process .....     | 114    |
| Change activity .....                   | 23     |
| Cleaning .....                          | 152    |
| cleaning cards (accessories) .....      | 175    |
| cleaning wipes (accessories) .....      | 175    |
| Clear paper jam .....                   | 128    |
| Combination button .....                | 20, 23 |
| Company (operating mode) .....          | 27     |
| Company card                            |        |
| Data .....                              | 32     |
| Display number .....                    | 106    |
| First insertion .....                   | 72     |
| Functions of the company card .....     | 71     |
| remove .....                            | 76     |
| Compulsory tachograph inspections ..... | 152    |
| Contact partner .....                   | 11     |
| Contact person .....                    | 11     |

|                                    |        |                                               |        |
|------------------------------------|--------|-----------------------------------------------|--------|
| Contrast.....                      | 23     | Driver 1/ Driver 2 .....                      | 104    |
| Control (operating mode) .....     | 27     | Driving and rest periods.....                 | 45     |
| Control card.....                  | 30     | Low voltage / overvoltage.....                | 155    |
| Country - when card inserted ..... | 55     | Standard displays during journey .....        | 44     |
| Country entry - manual.....        | 57     | VDO Counter (option).....                     | 119    |
| Country symbols                    |        | vehicle .....                                 | 105    |
| Spanish regions.....               | 41     | When driving.....                             | 44     |
| Table with overview .....          | 40     | when the vehicle is stationary.....           | 79     |
| Crew operation .....               | 10, 67 | Displaying the times of the driver card ..... | 80     |
| <b>D</b>                           |        | DLK Smart Download Key .....                  | 173    |
| Data                               |        | DLKPro Compact S.....                         | 173    |
| Download from mass data .....      | 51     | DLKPro Download Key S.....                    | 173    |
| downloading.....                   | 51     | Driver / vehicle change                       |        |
| Identification.....                | 51     | Inserting cards.....                          | 67     |
| Protection of personal data .....  | 68     | Mixed operation .....                         | 67     |
| Data backup by the workshop .....  | 155    | Shift end .....                               | 67     |
| Data memory                        |        | Driver 1 definition .....                     | 10     |
| Definition .....                   | 11     | Driver card                                   |        |
| Data protection .....              | 9      | Data .....                                    | 32     |
| Data storage.....                  | 32     | Description.....                              | 29     |
| Digital signature.....             | 51     | First insertion .....                         | 56, 68 |
| Dimming .....                      | 23, 25 | Functions .....                               | 53     |
| Display.....                       | 20, 23 | Obligations of the driver.....                | 16     |
|                                    |        | remove.....                                   | 61     |
|                                    |        | Validity.....                                 | 17     |
|                                    |        | Driving and rest periods .....                | 45     |
|                                    |        | Driving time warning.....                     | 118    |

|                   |     |
|-------------------|-----|
| Message .....     | 110 |
| DTCO version..... | 106 |

**E**

|                                          |          |
|------------------------------------------|----------|
| EC 2006/22 .....                         | 16       |
| EC 561/2006 .....                        | 16       |
| Enter Loading .....                      | 61       |
| Enter Unloading.....                     | 61       |
| Enter vehicle registration number.....   | 74       |
| With app.....                            | 25       |
| Entry                                    |          |
| Driver 1/ Driver 2 - country.....        | 95       |
| Driver 1/ driver 2 - start country ..... | 96       |
| end country .....                        | 96       |
| Ferry / train .....                      | 99       |
| Local time .....                         | 100      |
| Local time company.....                  | 101      |
| Unlocking additional functions .....     | 102      |
| Vehicle - out start/end.....             | 99       |
| Error messages .....                     | 109, 117 |
| EU 165/2014 .....                        | 16       |
| Events - overview .....                  | 114      |
| Ex-device.....                           | 25       |

**F**

|        |  |
|--------|--|
| Faults |  |
|--------|--|

|                       |            |
|-----------------------|------------|
| Message .....         | 109        |
| Ferry / train         |            |
| Entry .....           | 99         |
| Ferry/ train          |            |
| Message .....         | 111        |
| Front interface ..... | 10, 20, 24 |

**I**

|                                       |     |
|---------------------------------------|-----|
| Ignition off - display .....          | 46  |
| Ignition on - Display.....            | 44  |
| Intended use .....                    | 18  |
| In-vehicle Bluetooth connection ..... | 101 |
| ITS Data .....                        | 10  |
| Release .....                         | 68  |

**L**

|                                       |     |
|---------------------------------------|-----|
| Language                              |     |
| Displayed language .....              | 48  |
| Set manually .....                    | 81  |
| When card inserted .....              | 53  |
| Leave scope (out) .....               | 111 |
| Load/unload - Menu .....              | 100 |
| Local time - when card inserted ..... | 55  |
| Local time company Entry.....         | 101 |
| Lock menu access .....                | 90  |
| Log in the company.....               | 73  |

**M**

|                                                 |          |
|-------------------------------------------------|----------|
| Malfunctions                                    |          |
| Overview .....                                  | 117      |
| Manual addition                                 |          |
| When card inserted .....                        | 54       |
| Manual entry .....                              | 63       |
| Continuing activities .....                     | 65       |
| Correction possibility .....                    | 63       |
| Precede activities with others activities ..... | 66       |
| Mass memory .....                               | 32       |
| Downloading data .....                          | 51       |
| Menu buttons .....                              | 20, 23   |
| In the Menu .....                               | 46       |
| Menu functions                                  |          |
| Leaving - automatically .....                   | 90       |
| Leaving - manually .....                        | 91       |
| navigate .....                                  | 89       |
| Menu levels .....                               | 87       |
| Messages .....                                  | 109, 122 |
| Causes .....                                    | 46       |
| Confirm .....                                   | 110      |
| Display in the display .....                    | 46       |
| Ferry/ train .....                              | 111      |
| Malfunction .....                               | 117      |
| Meaning .....                                   | 109      |
| Mixed operation .....                           | 10       |

**N**

|             |    |
|-------------|----|
| NUTS0 ..... | 33 |
|-------------|----|

**O**

|                                    |     |
|------------------------------------|-----|
| Online Shop .....                  | 175 |
| Operational (operating mode) ..... | 27  |
| Out (leave scope) .....            | 111 |
| Out of Scope .....                 | 11  |
| enter .....                        | 99  |

**P**

|                              |     |
|------------------------------|-----|
| Permitted total weight ..... | 106 |
| Personal data .....          | 10  |
| change .....                 | 97  |
| Pictograms                   |     |
| Combinations .....           | 37  |
| Overview .....               | 35  |
| Print                        |     |
| Activities .....             | 92  |
| cancel .....                 | 127 |
| Events .....                 | 92  |
| start .....                  | 126 |
| Print: Daily value .....     | 91  |
| Printer .....                | 20  |
| Printout                     |     |

|                                    |     |
|------------------------------------|-----|
| Daily value .....                  | 93  |
| Driver 1/ Driver 2.....            | 91  |
| Events [vehicle].....              | 93  |
| Information tachograph cards ..... | 94  |
| Rpm profiles (option) .....        | 95  |
| Speed profiles (option).....       | 95  |
| Speeding events .....              | 93  |
| Status D1/ D2 (option) .....       | 94  |
| Technical data .....               | 93  |
| v-diagram .....                    | 94  |
| Vehicle .....                      | 92  |
| Production status - display .....  | 110 |

**R**

|                                     |     |
|-------------------------------------|-----|
| Recording activities manually ..... | 60  |
| Release overview .....              | 177 |
| Remote control .....                | 24  |
| Remote DL 4G .....                  | 174 |
| Remote-controlled download.....     | 51  |
| Replace printer paper .....         | 127 |

**S**

|                                    |        |
|------------------------------------|--------|
| Service partner .....              | 11     |
| Set activities automatically ..... | 41, 59 |
| Setting activities .....           | 59     |

|                            |     |
|----------------------------|-----|
| Change activity .....      | 59  |
| When card inserted .....   | 57  |
| Shift start .....          | 53  |
| Signature data .....       | 51  |
| Software version .....     | 106 |
| Standard display (a) ..... | 44  |
| Standard displays.....     | 79  |
| Stand-by .....             | 25  |
| Symbol - Pictograms .....  | 35  |

**T**

|                          |     |
|--------------------------|-----|
| tachograph card .....    | 29  |
| Automatic ejection ..... | 157 |
| Cleaning .....           | 152 |
| plug.....                | 47  |
| remove.....              | 49  |
| Target group.....        | 11  |
| Technical data.....      | 159 |
| Time zones.....          | 33  |
| Toll (menu).....         | 107 |
| Towing.....              | 100 |
| Transporting .....       | 100 |

**U**

|                        |     |
|------------------------|-----|
| UKCA Explanation ..... | 163 |
| UTC time .....         | 33  |



**V**

---

|                                         |     |
|-----------------------------------------|-----|
| VDO Counter                             |     |
| Description.....                        | 81  |
| Description of the display.....         | 82  |
| Display .....                           | 45  |
| Display daily values .....              | 86  |
| Display weekly values.....              | 86  |
| Displays for rest time activity .....   | 84  |
| Displays for working time activity..... | 85  |
| Status display .....                    | 86  |
| VDO Data .....                          | 10  |
| Release.....                            | 69  |
| VDO Link .....                          | 174 |
| Vehicle weight .....                    | 106 |
| Voltage interruption .....              | 156 |

**W**

---

|                              |     |
|------------------------------|-----|
| Warning - Driving time ..... | 118 |
| Working time warning .....   | 118 |
| Workshop card .....          | 30  |





Continental Automotive Technologies GmbH  
P.O. Box 1640  
78006 Villingen-Schwenningen  
Germany  
[www.fleet.vdo.com](http://www.fleet.vdo.com)

AAA2242730000 / AAA2242730029  
70122052 SPE 000 AC  
BA00.1381.41 100 102  
Language: English

Version 041a

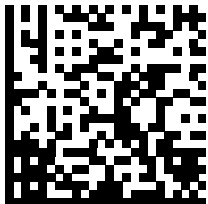

**VDO**  
Smart on the Road